

Optima balcony privacy screen curtain profile

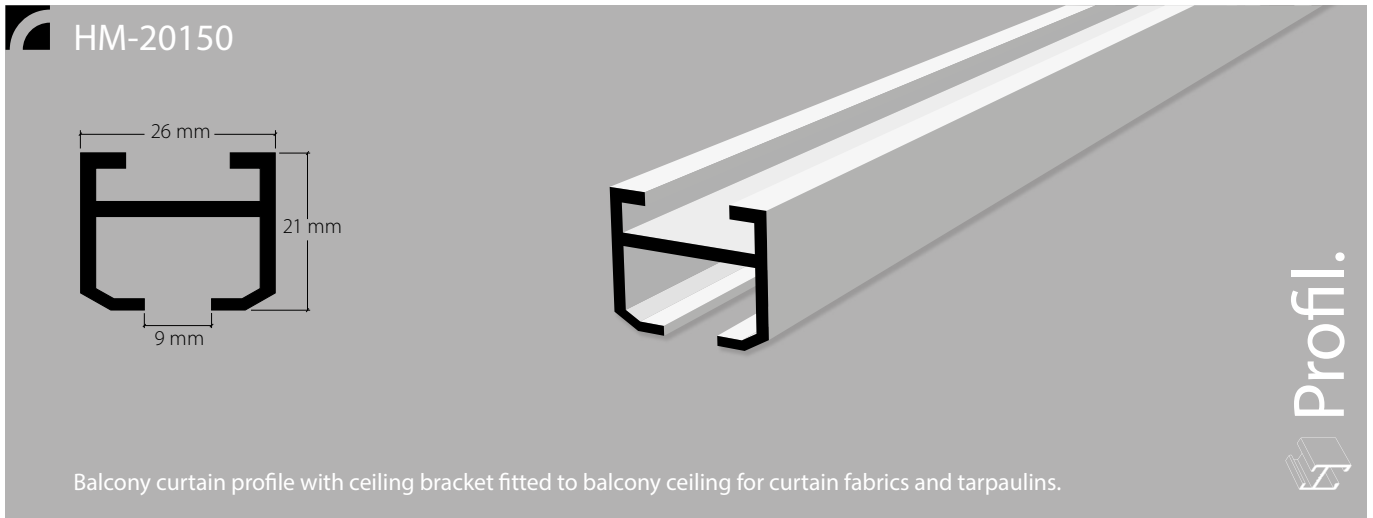

Aluminium, natural anodised

Aluminium, white, RAL 9016

Stock lengths of 4 m and 6 m

Aluminium, grey, RAL 7038

Accessories

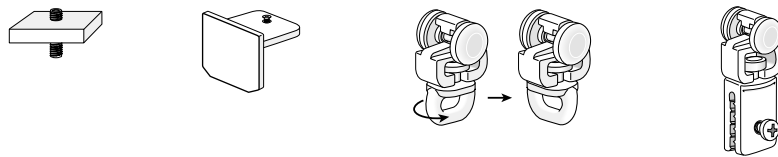

Installation accessories

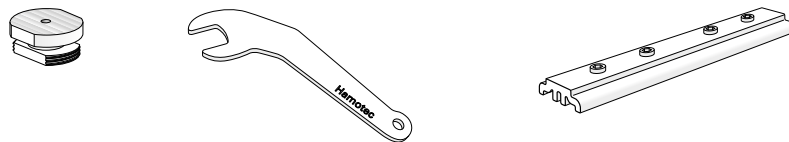

Installation

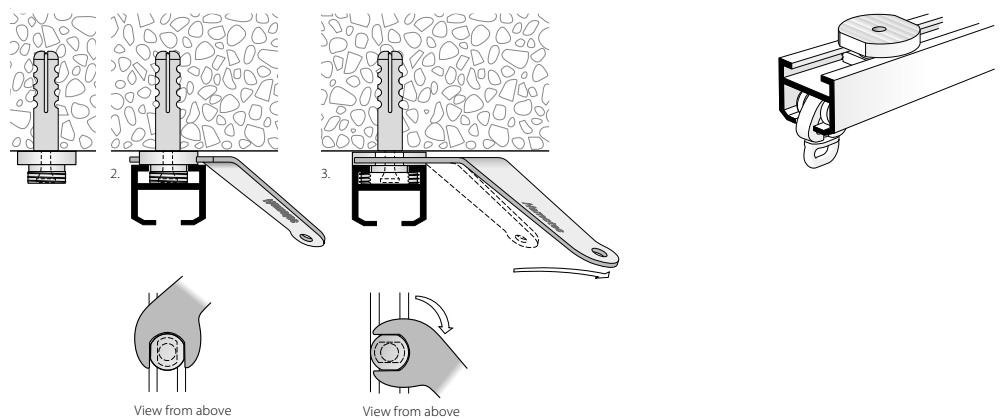

Services

Plan view (seen from above). State room side.

Bending service

View is always from above with the channel below.



Radii: from 200 mm
90° angle or angle of your choice



Non-standard radii and angles as per sketch

Article description

Order no.

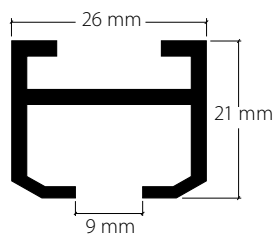

Optima balcony privacy screen curtain profile
for curtain fabrics and tarpaulin panels

Aluminium, natural anodised

20150.10

Aluminium, grey, RAL 7038

20150.11

Aluminium, white, RAL 9016

20150.20



Stock lengths of 4 m and 6 m

Made-to-measure + 20%

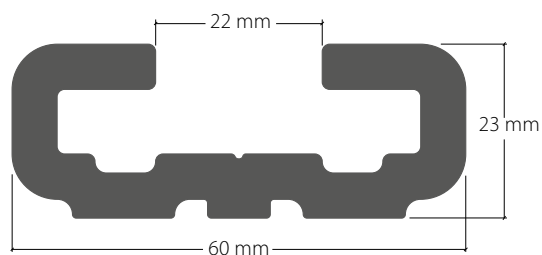

C-profile for tie-back system

Aluminium, natural anodised

20155.10

Aluminium, grey, RAL 7038

20155.11

Aluminium, white, RAL 9016

20155.20





Stock lengths of 6 m

Made-to-measure + 20%

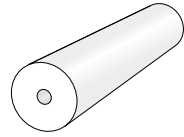
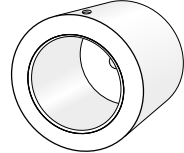
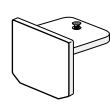
	Article description	Order no.
	Angle adapter for C-profile	
	Aluminium, natural anodised	21221.10
	Aluminium, grey, RAL 7038	21221.11
	Aluminium, white, RAL 9016	21221.20
	Side angle adapter for C-profile	
	Aluminium, natural anodised	21222.10
	Aluminium, grey, RAL 7038	21222.11
	Aluminium, white, RAL 9016	21222.20
	Clip for C-profile for tie-back system	
	Plastic, grey	21223.14
	Plastic, white	21223.20
	End cover for C-profile	
	Aluminium, natural anodised	21228.10
	Aluminium, grey, RAL 7038	21228.11
	Aluminium, white, RAL 9016	21228.20

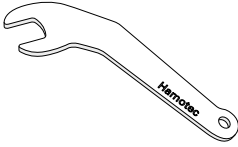
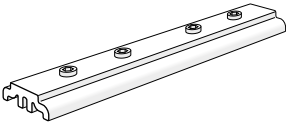
	Article description	Order no.
	Bolts Ø 25 mm for HM-20150 for lowered installation	
	Aluminium, natural anodised	21240.10
	Aluminium, grey, RAL 7038	21240.11
	Aluminium, white, RAL 9016	21240.20
	Stock lengths of 3 m	
	Sleeve 40 x 25 mm for bolt Ø 25 mm	
	Aluminium, natural anodised	21241.10
	Aluminium, grey, RAL 7038	21241.11
	Aluminium, white, RAL 9016	21241.20
	Side cap S20150	
	Aluminium, silver-coloured	21208.10
	Aluminium, grey, RAL 7038	21208.11
	Aluminium, white, RAL 9016	21208.20

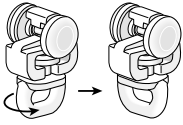
	Article description	Order no.
	Ceiling bracket, thickness 6 mm	
	Aluminium, polished	21207.10
	Aluminium, grey, RAL 7038	21207.11
	Aluminium, white, RAL 9016	21207.20
	Open-ended spanner for turning ceiling bracket 21206	19897
	Profile connector V209 aluminium	21209
	Locking device C110, iron with M4x14 threaded pin	25200
	Roller, metal, with clamping eyelet for balcony profile HM-20110 and HM-20150	
	Grey	21210.14
	White	21210.20
	Eyelet roller with rotating sewn eyelet for balcony profile HM-20110 and HM-20150	
	Plastic, grey	21211.14
	Plastic, white	21211.20

	Article description	Order no.
--	---------------------	-----------

Bending service**Plan view** (seen from above). State room side.**Radii:** from 200 to 1000 mm

95.20150.1

90° angle or angle of your choice

**Non-standard radii and angles as per sketch**

95.20150.4