

Curtain profile for embedding in plaster, 2-channel with "maxi" channel, VS57 standard

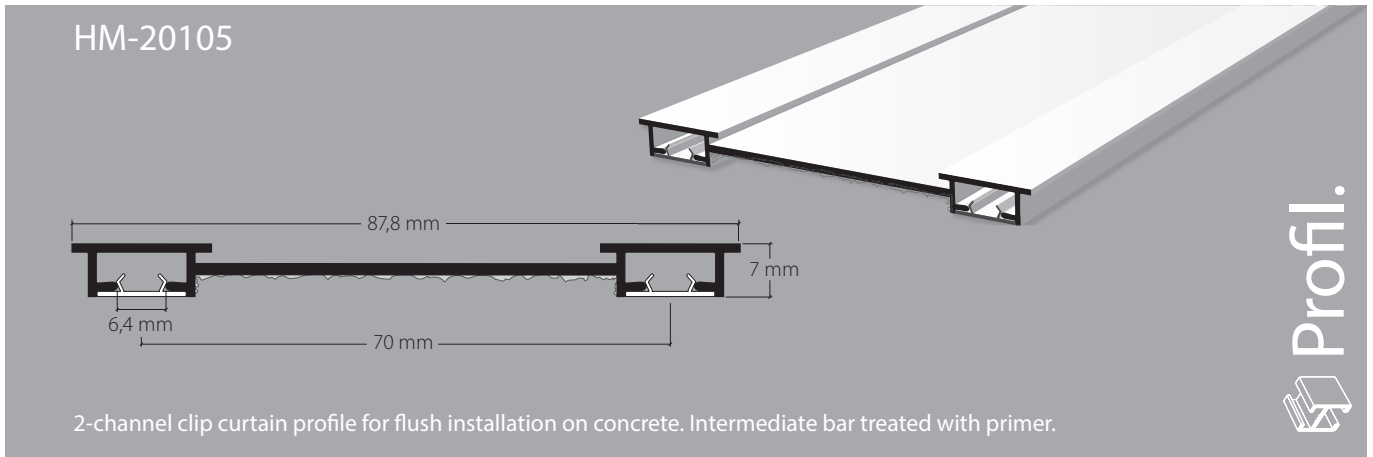

Profil.

Aluminium, white, RAL 9016

Stock lengths of 4 m, 5 m and 6 m

"maxi" accessories



Installation accessories

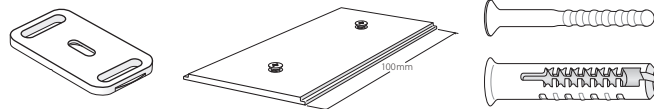

Dowels, plastic with bolts, grooved for levelling
8 mm drill hole for dowel 8 mm

Installation

Ceiling installation

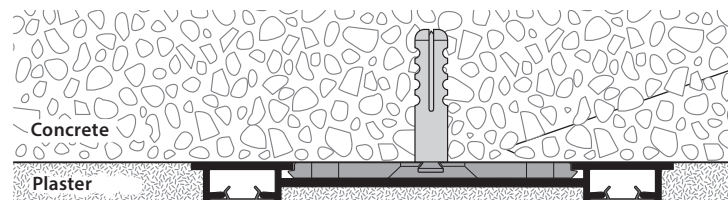

Fixings approx. every 40-50 cm

The special bonding course should not be applied in sub-zero temperatures (icing condition). High humidity levels should also be avoided. The bonding course (ceiling plaster) should be applied quickly (within 24 h), as the molecular structure of the bonding agent can change with air / humidity fluctuations and thus cause the bonding agent to peel off. The special bonding course must not be thinned. The special bonding course is not suitable as an insulating coating. It is suitable as a substrate for base coats, smooth plasters, fillers, etc. The applicable standards, SIA recommendations, leaflets of the Swiss Painting and Plastering Contractors Association SMGV as well as the current state of construction technology apply as a basis.

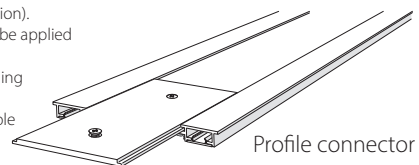

Profile connector

Services

Made-to-measure including opening / insert
This profile has been treated with primer



Handling specification: Ceiling treatment with primer.

Curved elements: 1-channel curved elements can be added.

Article description	Order no.
---------------------	-----------

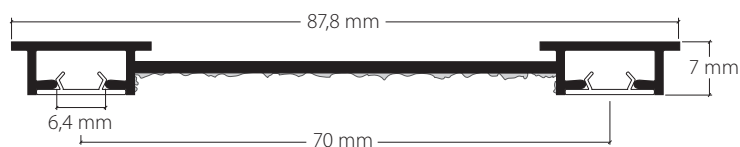

2-channel flush curtain profile with "maxi" channel
 VS57 standard, for clip bracket installation and treated with primer, plaster protective strip inserted

Aluminium, white, RAL 9016

20105.20.AP

Stock lengths of 4 m, 5 m and 6 m

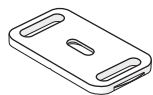

Ceiling clip bracket KL20105 / 208
 for 2-channel curtain profile HM-20105 and 20208

Plastic

21057

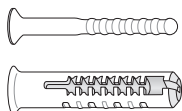

Dowel with grid pin, plastic
 for installation clip 21057 for levelling
 8 mm drill hole for dowel 8 mm

55960

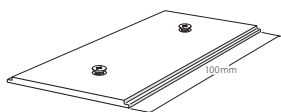

Profile connector V20105 / 208
 for 2-channel curtain profile HM-20105 and 20208

Unfinished aluminium

21056



Installation adhesive cartridge, 290 ml
 for indoor and outdoor installation

13828