

Two-groove curtain profile "maxi", standard VS57 for surface mounting with rotary plate

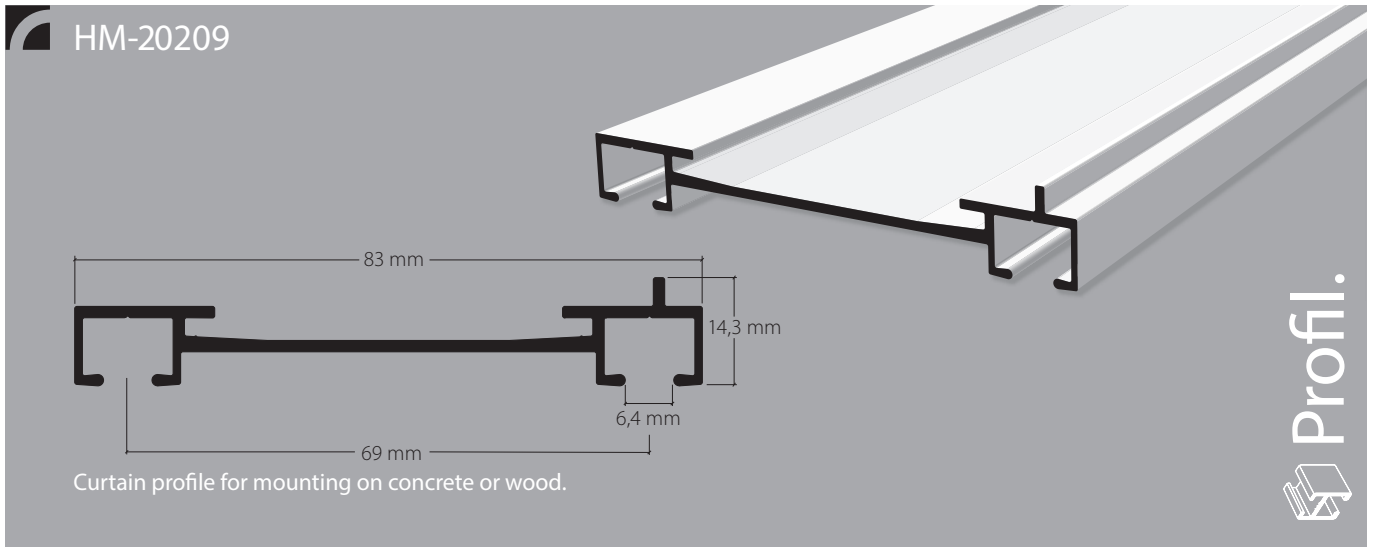

Aluminium, natural anodised

Aluminium, white, RAL 9016

Stock lengths of 4 m and 6 m

"maxi" accessories

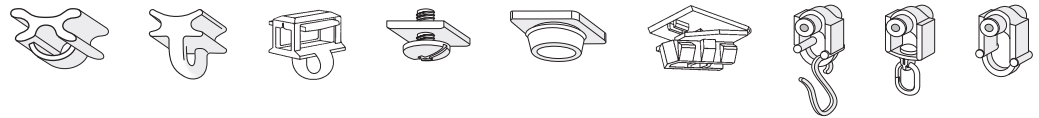

Installation accessories

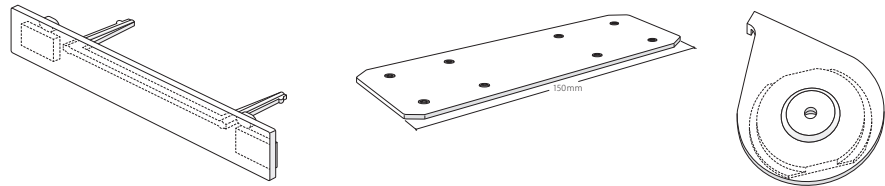

Services

Made-to-measure including opening

Bending service

This profile cannot be bent

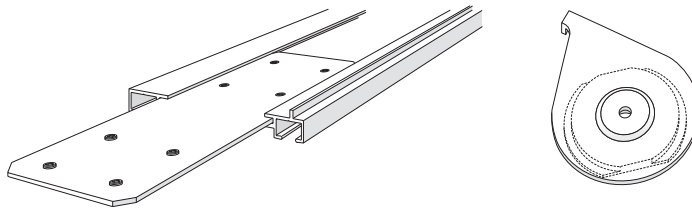
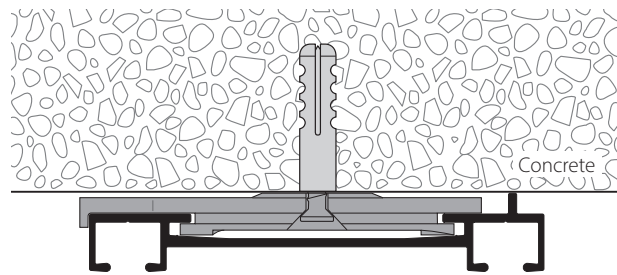
Montage**Features:**

- Surface mounting with rotating plate every 50-60 cm (approx.)
- Can be used with curtain accessories VS57 gliders or roller rings
- For heavy curtains
- Available lengths: 4 or 6 m

Article description	Order no.
---------------------	-----------

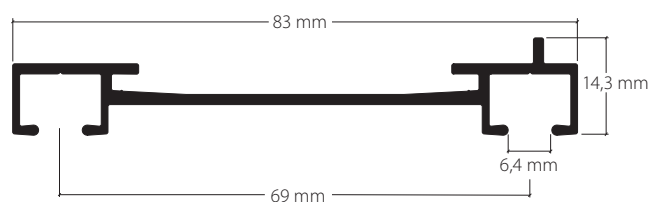

Two-groove curtain profile "maxi", standard VS57 for surface mounting with rotary plate

Aluminium, natural anodised 20209.10

Aluminium, white, RAL 9016 20209.20

Stock lengths of 4 m and 6 m

Made-to-measure + 20%

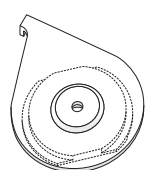

Rotating plate

Plastic 21036.20

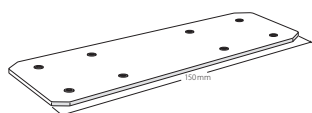

Profile connector

Unfinished aluminium 21066

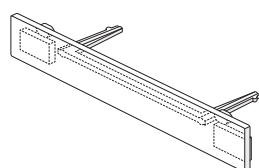

Side cap

Plastic, grey 21029.10

Plastic, white 21029.20

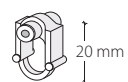

Eyelet roller, white plastic with shaft 25287

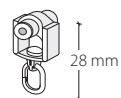

Eyelet roller, white plastic with rotatable eyelet 25288

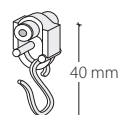

Eyelet roller, white plastic with metal hook 25289