

Two-run curtain profile perforated with "maxi" running groove, VS57 standard

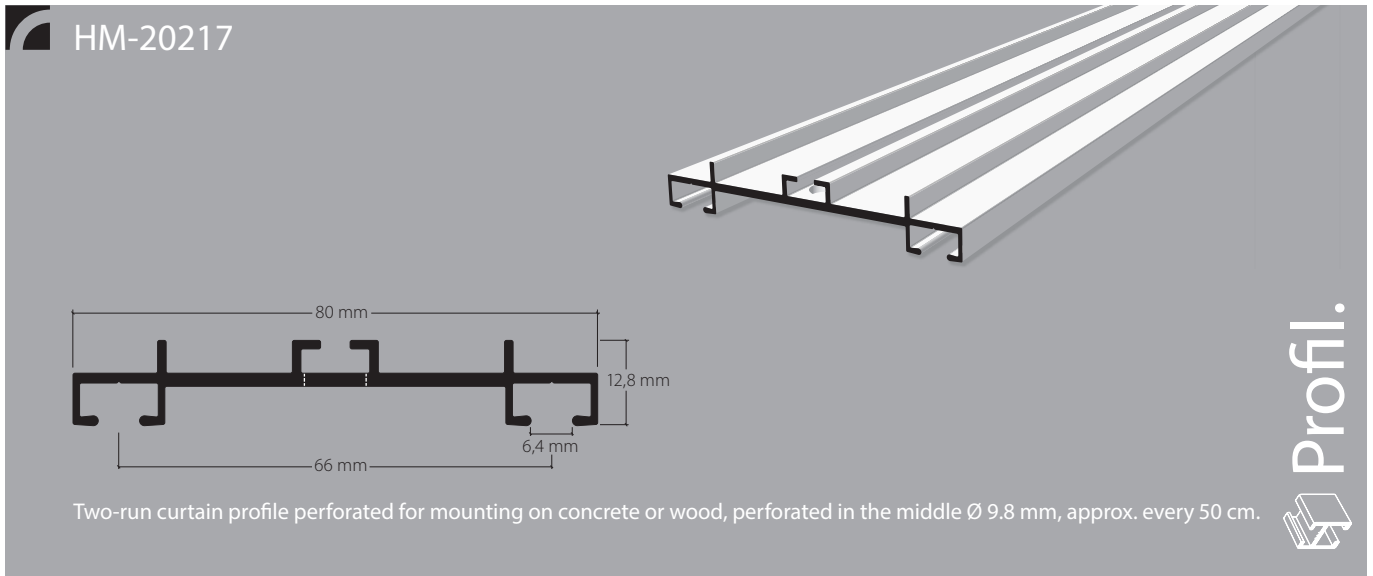

Profil.



Aluminium, white RAL 9016

Aluminium, natural anodised

Stock lengths of 4 m and 6 m

"maxi" accessories

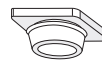

Installation accessories

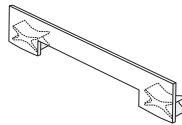

Services

Made-to-measure including opening and mitre

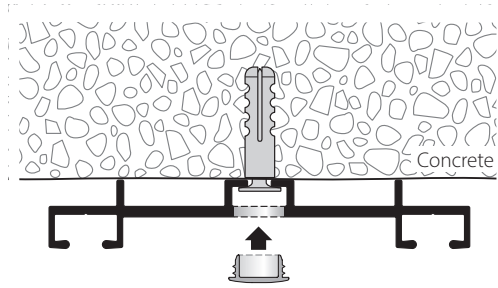

This profile cannot be bent

**Installation**

**Caution:** Opening / glider entry is only possible with "maxi" punch head.

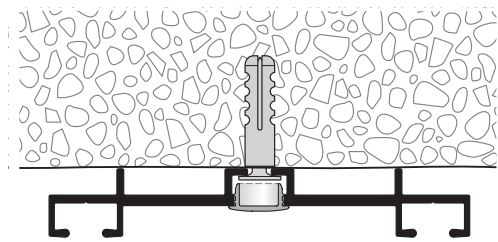
**Features:**

- Perforated profile for mounting on concrete or wood
- Perforated in the centre  $\varnothing$  9.8 mm, approx. every 50 cm
- Perforation covering with plastic plugs

| Article description | Order no. |
|---------------------|-----------|
|---------------------|-----------|

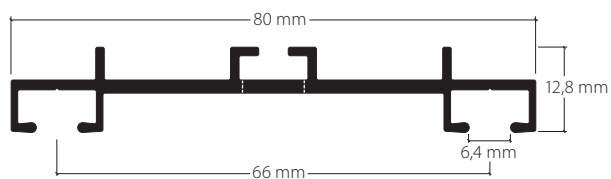

**"maxi" 2-channel curtain profile**  
Centrally perforated approx. every 50 cm  
for mounting on concrete or wood

Aluminium, white, RAL 9016 20217.10

Aluminium white, Ral 9016 20217.20  
Stock lengths of 4 m and 6 m



Stock lengths of 4 m and 6 m

Made-to-measure + 20%



**V1 profile connector, spring steel**

blank 11001

white 11001.20

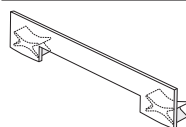

**S2019 side closure**

Plastic gray 21026.14

Plastic white 21026.20



**Plastic sealing plug**  
to cover the perforation

gray 55075.14

white 55075.20