

HAMOTEC

Curtain profile systems for indoors and outdoors

3





Profil.

Curtain profile systems for indoors and outdoors

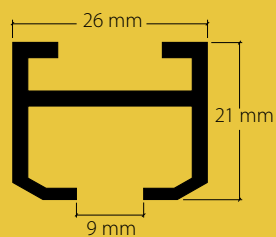

HM-20150
Seite / page 1

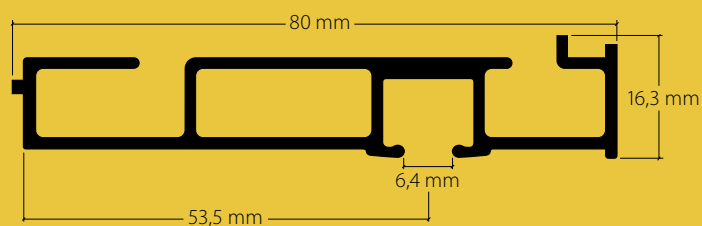

HM-20371 «maxi»
Seite / page 7

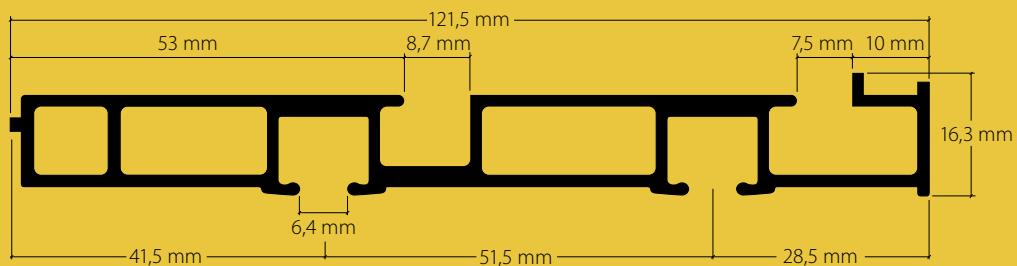

HM-20372 «maxi»
Seite / page 11

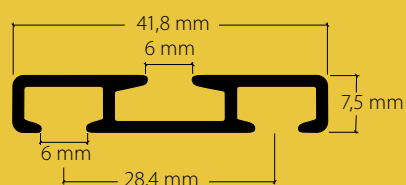

HM-20501/502 «maxi» / «sixo»
Seite / page 15

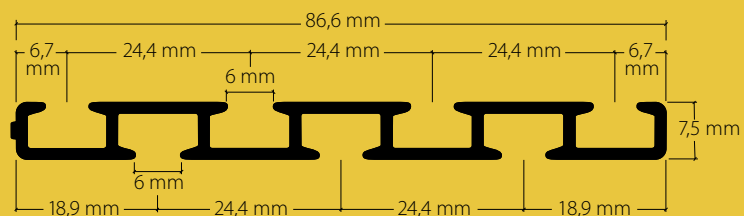

HM-20503/504 «maxi» / «sixo»
Seite / page 19

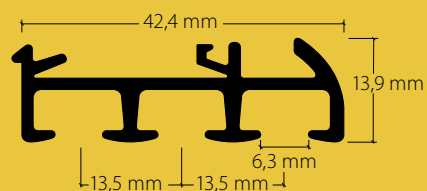

HM-20803 «maxi»
Seite / page 23

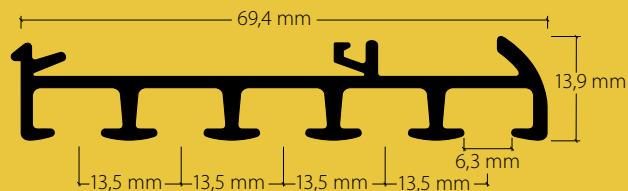

HM-20805 «maxi»
Seite / page 29

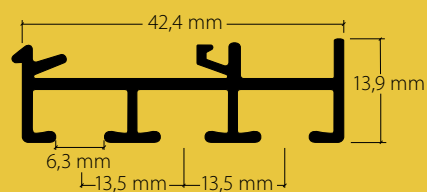

HM-20813 «maxi»
Seite / page 35

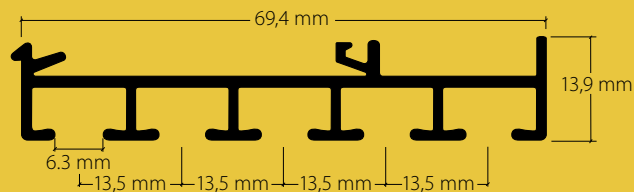

HM-20815 «maxi»
Seite / page 41



Profil.

Optima balcony privacy screen curtain profile

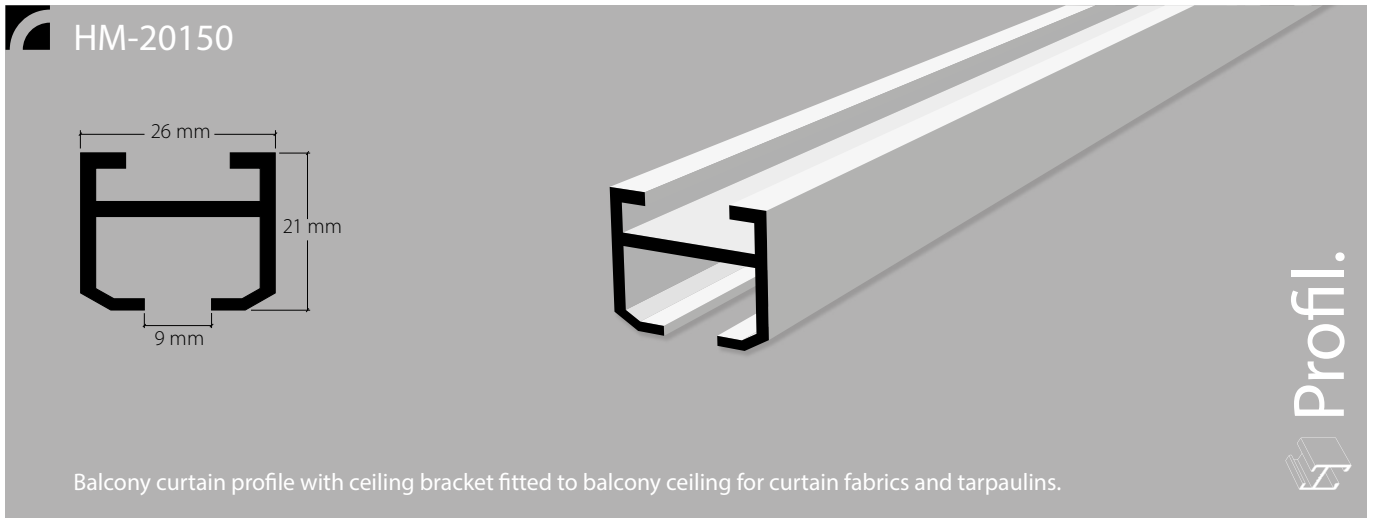

Aluminium, natural anodised

Aluminium, white, RAL 9016

Stock lengths of 4 m and 6 m

Aluminium, grey, RAL 7038

Accessories

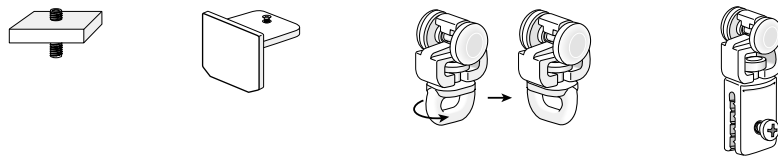

Installation accessories

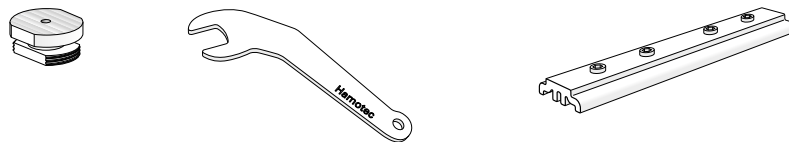

Installation

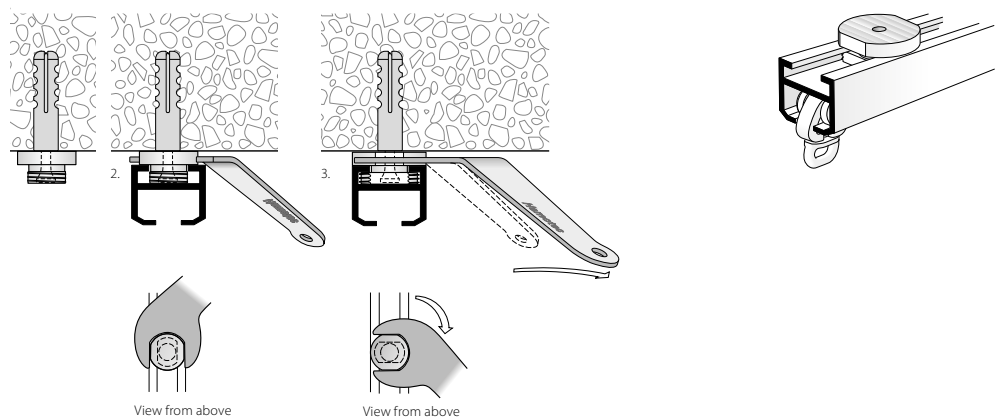

Services

Plan view (seen from above). State room side.

Bending service

View is always from above with the channel below.



Radii: from 200 mm
90° angle or angle of your choice



Non-standard radii and angles as per sketch

Article description

Order no.

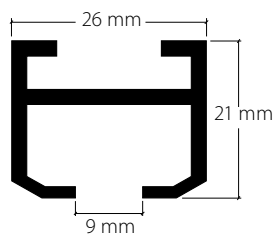

Optima balcony privacy screen curtain profile
for curtain fabrics and tarpaulin panels

Aluminium, natural anodised

20150.10

Aluminium, grey, RAL 7038

20150.11

Aluminium, white, RAL 9016

20150.20



Stock lengths of 4 m and 6 m

Made-to-measure + 20%

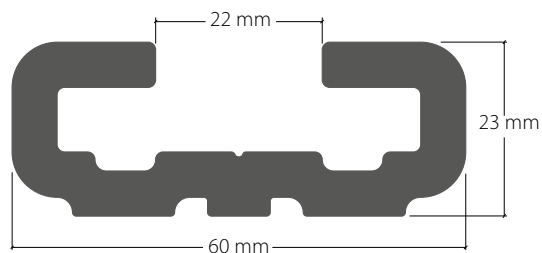

C-profile for tie-back system

Aluminium, natural anodised

20155.10

Aluminium, grey, RAL 7038

20155.11

Aluminium, white, RAL 9016

20155.20





Stock lengths of 6 m

Made-to-measure + 20%

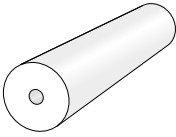
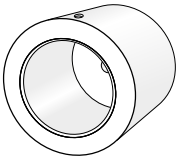
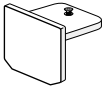
	Article description	Order no.
	Angle adapter for C-profile	
	Aluminium, natural anodised	21221.10
	Aluminium, grey, RAL 7038	21221.11
	Aluminium, white, RAL 9016	21221.20
	Side angle adapter for C-profile	
	Aluminium, natural anodised	21222.10
	Aluminium, grey, RAL 7038	21222.11
	Aluminium, white, RAL 9016	21222.20
	Clip for C-profile for tie-back system	
	Plastic, grey	21223.14
	Plastic, white	21223.20
	End cover for C-profile	
	Aluminium, natural anodised	21228.10
	Aluminium, grey, RAL 7038	21228.11
	Aluminium, white, RAL 9016	21228.20

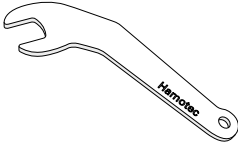
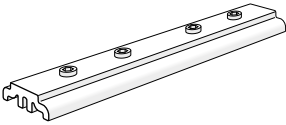
	Article description	Order no.
	<p>Bolts Ø 25 mm for HM-20150 for lowered installation</p> <p>Aluminium, natural anodised</p> <p>Aluminium, grey, RAL 7038</p> <p>Aluminium, white, RAL 9016</p> <p>Stock lengths of 3 m</p>	<p>21240.10</p> <p>21240.11</p> <p>21240.20</p>
	<p>Sleeve 40 x 25 mm for bolt Ø 25 mm</p> <p>Aluminium, natural anodised</p> <p>Aluminium, grey, RAL 7038</p> <p>Aluminium, white, RAL 9016</p>	<p>21241.10</p> <p>21241.11</p> <p>21241.20</p>
	<p>Side cap S20150</p> <p>Aluminium, silver-coloured</p> <p>Aluminium, grey, RAL 7038</p> <p>Aluminium, white, RAL 9016</p>	<p>21208.10</p> <p>21208.11</p> <p>21208.20</p>

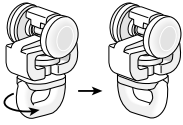
	Article description	Order no.
 6 mm	Ceiling bracket, thickness 6 mm	
	Aluminium, polished	21207.10
	Aluminium, grey, RAL 7038	21207.11
	Aluminium, white, RAL 9016	21207.20
	Open-ended spanner for turning ceiling bracket 21206	19897
	Profile connector V209 aluminium	21209
	Locking device C110, iron with M4x14 threaded pin	25200
	Roller, metal, with clamping eyelet for balcony profile HM-20110 and HM-20150	
	Grey	21210.14
	White	21210.20
	Eyelet roller with rotating sewn eyelet for balcony profile HM-20110 and HM-20150	
	Plastic, grey	21211.14
	Plastic, white	21211.20

	Article description	Order no.
--	---------------------	-----------

Bending service**Plan view** (seen from above). State room side.**Radii:** from 200 to 1000 mm

95.20150.1

90° angle or angle of your choice

**Non-standard radii and angles as per sketch**

95.20150.4

Curtain gallery profile system with "maxi" channel, VS57 standard

HM-20371

1-channel curtain gallery profile, aluminium, for installation with clip brackets on concrete or wood. Suitable for use with VS57 accessories. Suitable for eyelet rollers.

Profil.



Aluminium, grey, RAL 7038

Aluminium, white matt, RAL 9016

Stock lengths of 6 m

"maxi" accessories

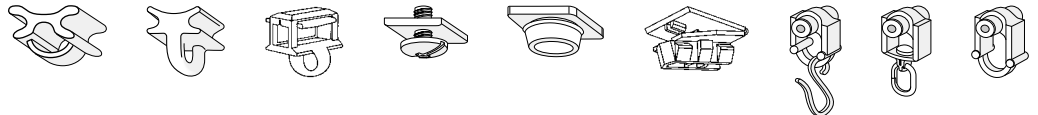

Installation accessories

Clip bracket for gallery profile

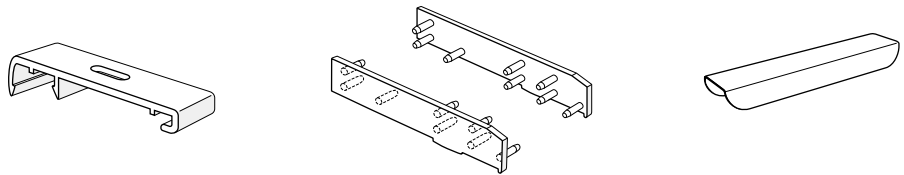

Soffit-wall spacer profile

Ceiling bracket for soffit-wall spacer profile

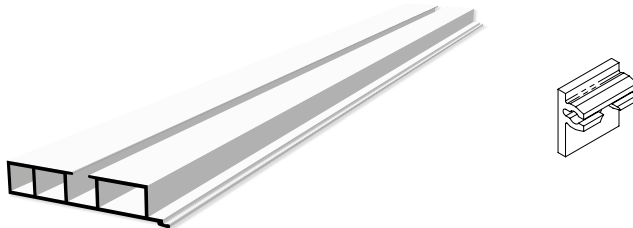

Services

Made-to-measure including opening/insert and mitre

Cutting service

Plan view (seen from above). State room side.

Installation

Installation of gallery profile

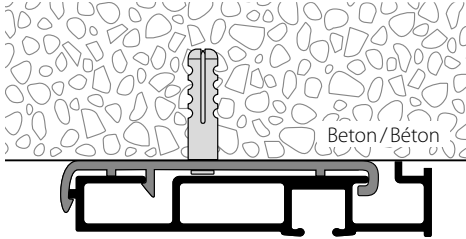

Installation with soffit-wall spacer profile

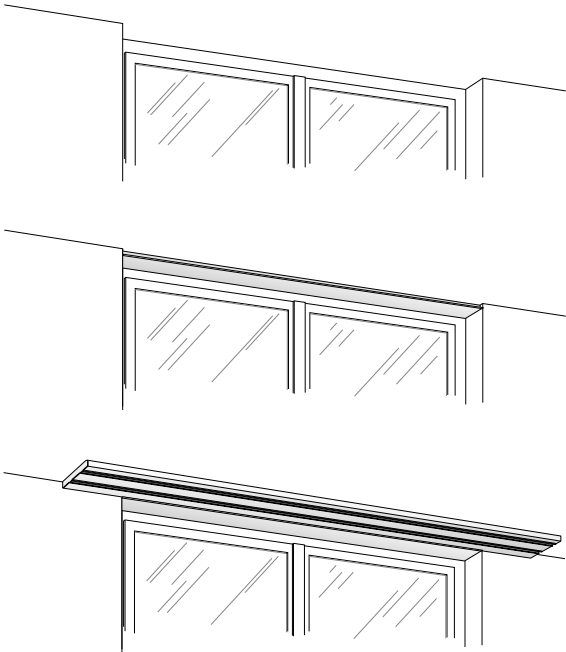
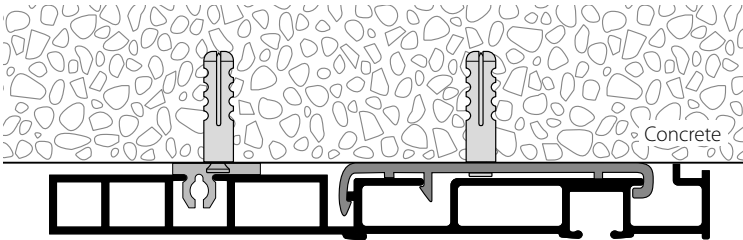

Article description	Order no.
---------------------	-----------

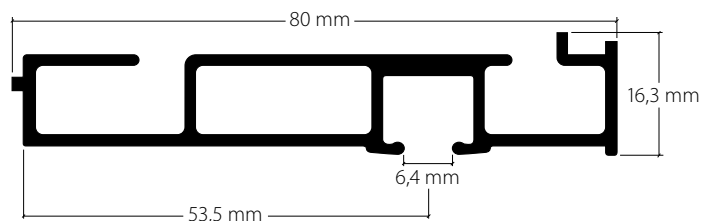

Curtain gallery profile system 80 x 16 mm 20371.11
1-channel

Aluminium, grey, RAL 7038

Aluminium, white matt, RAL 9016 20371.21



Stock lengths of 6 m

Made-to-measure + 20%

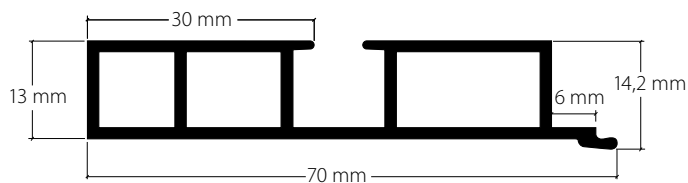

Soffit-wall spacer profile 70 x 14.2 mm 20376.11

Aluminium, grey, RAL 7038

Aluminium, white matt, RAL 9016 20376.21



Stock lengths of 6 m

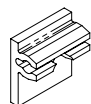

Made-to-measure + 20%

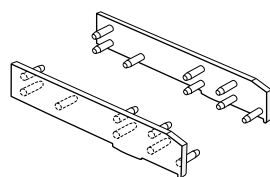

Clip bracket, white plastic 21303.20
for soffit-wall spacer profile 20376

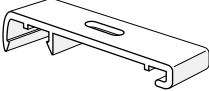
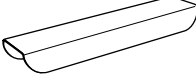
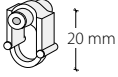

Side cap S371 21075.14
Plastic, grey
Plastic, white 21075.20

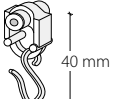
	Article description	Order no.
	Clip bracket, white plastic	21505.20
	Profile connector V371 / 72 Spring steel, white	21079.20
 20 mm	Eyelet roller, white plastic with shaft	25287
 28 mm	Eyelet roller, white plastic with rotatable eyelet	25288
 40 mm	Eyelet roller, white plastic with metal hook	25289

Curtain gallery profile system with "maxi" channel, VS57 standard

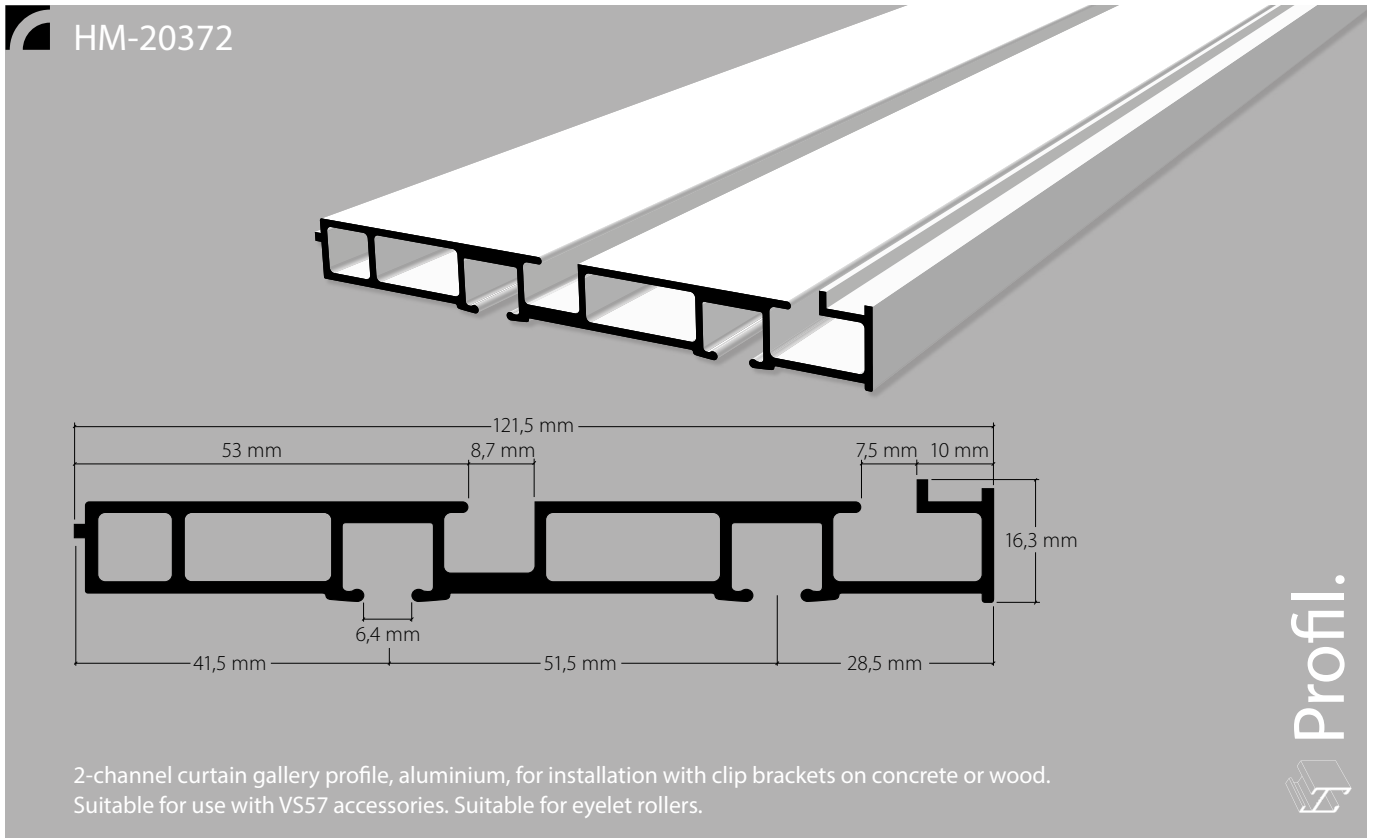

Aluminium, grey, RAL 7038

Aluminium, white matt, RAL 9016

Stock lengths of 6 m

"maxi" accessories

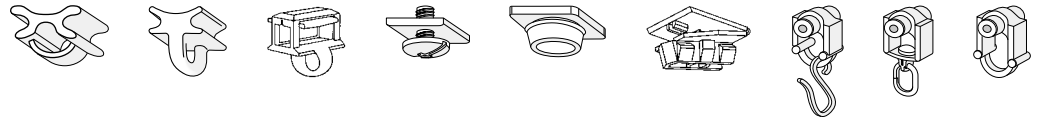

Installation accessories

Clip bracket for gallery profile

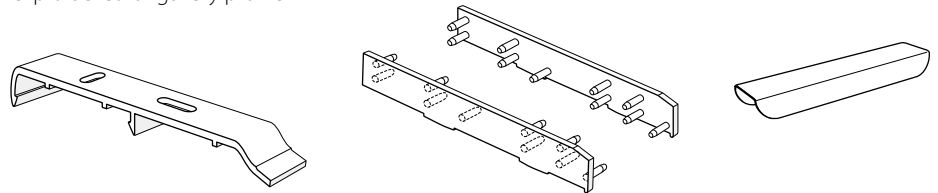

Soffit-wall spacer profile

Ceiling bracket for soffit-wall spacer profile

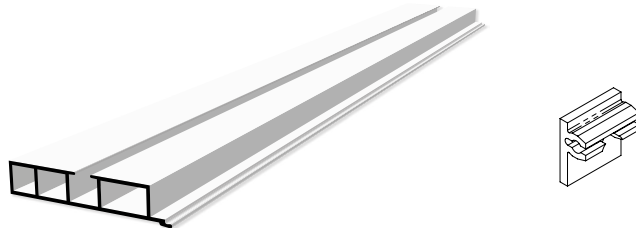

Services

Made-to-measure including opening/insert and mitre

Cutting service

Plan view (seen from above). State room side.

Installation

Installation of gallery profile

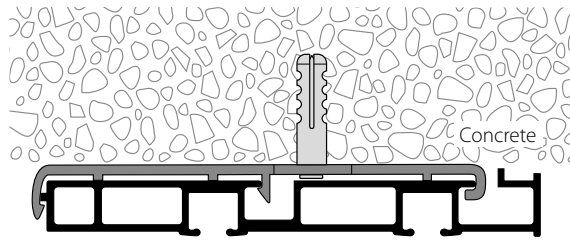

Installation with soffit-wall spacer profile

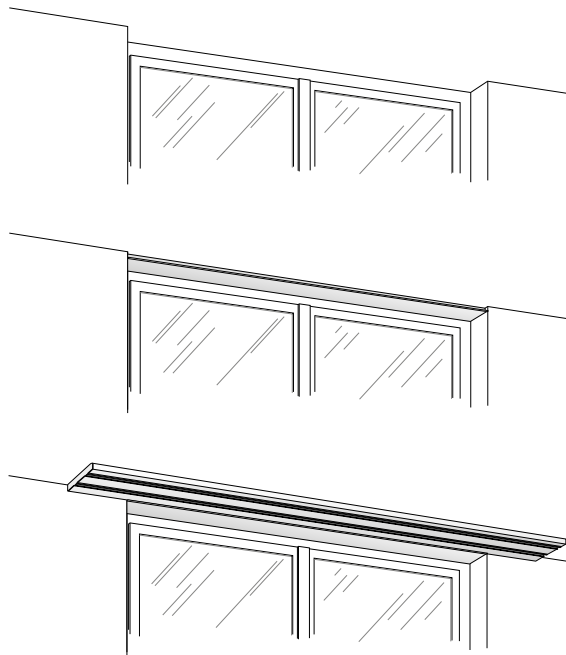
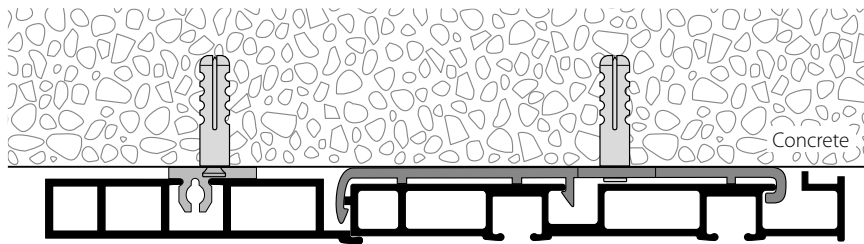

Article description	Order no.
---------------------	-----------

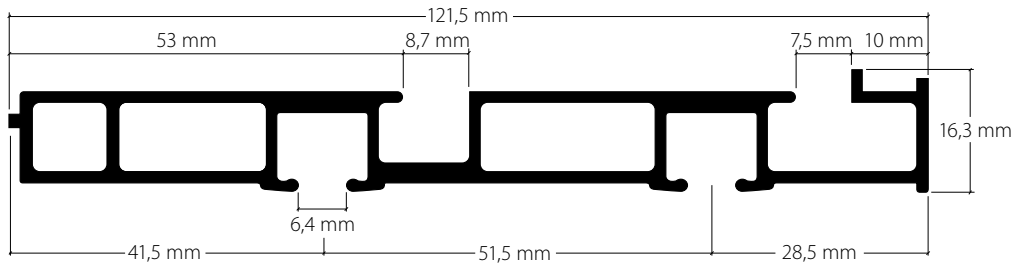

Curtain gallery profile system 120 x 16 mm 20372.11
2-channel

Aluminium, grey, RAL 7038

Aluminium, white matt, RAL 9016 20372.21



Stock lengths of 6 m

Made-to-measure + 20%

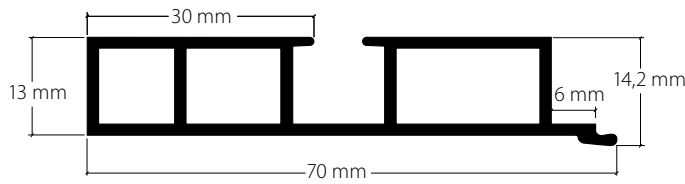

Soffit-wall spacer profile 70 x 14.2 mm 20376.11

Aluminium, grey, RAL 7038

Aluminium, white matt, RAL 9016 20376.21



Stock lengths of 6 m

Made-to-measure + 20%

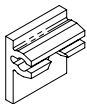

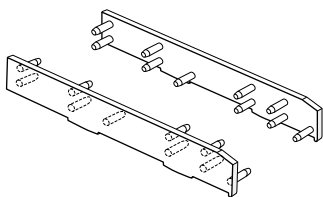

Clip bracket, white plastic
for soffit-wall spacer profile 20376 21303.20

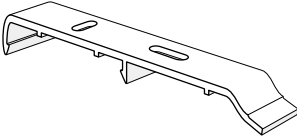
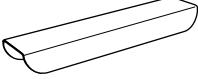

Side cap S372
Plastic, grey 21076.14

Plastic, white 21076.20

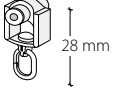
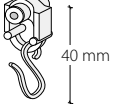
	Article description	Order no.
	Clip bracket, white plastic	21072.20
	Profile connector V371 / 72 Spring steel, white	21079.20
	Eyelet roller, white plastic with shaft	25287
	Eyelet roller, white plastic with rotatable eyelet	25288
	Eyelet roller, white plastic with metal hook	25289

1- to 2-channel reversible rail with "maxi"/"sixo" channel

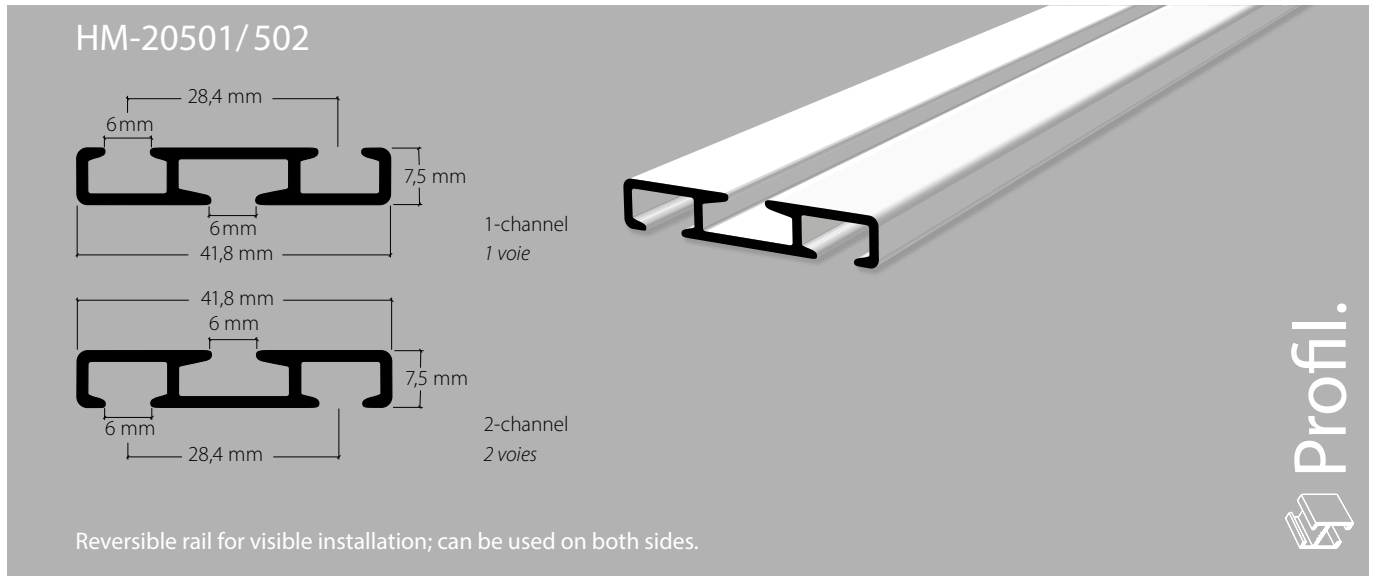

	Aluminium, natural anodised	Aluminium, white, RAL 9016	Stock lengths of 6 m
"maxi" accessories			 HC3 SIXO
Installation accessories			
Services	Made-to-measure including opening/insert, countersunk drill holes and mitre		
Bending service	This profile cannot be bent		

Installation instructions, see next page

Installation

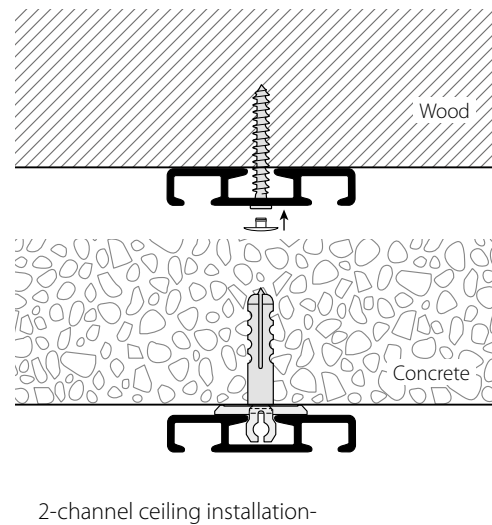
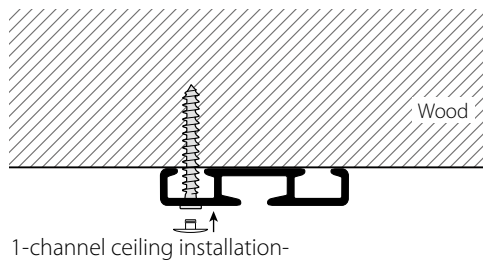

Countersunk drill hole every 40-50 cm along profile, white cap

Ordering information:

Please state whether 1-channel HM-20501 or 2-channel HM-20502 is being used for drill holes

Opening / glider entry is only possible with "midi" punch head.

Article description	Order no.
---------------------	-----------

Reversible rail, can be used on both sides,
once 1-channel and reversed 2-channel,
countersunk drill holes

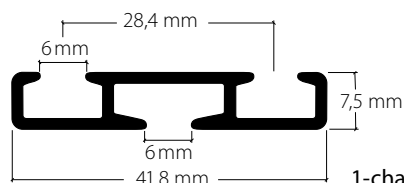

1-channel / 2-channel
Aluminium, natural anodised 20501.10

1-channel / 2-channel
Aluminium, white, RAL 9016 20501.20

Drill hole for Topspan
universal screw 4.5 x ... 95.20801



Stock lengths of 6 m

Made-to-measure + 20%

Opening / glider entry is only possible with "midi" punch head.

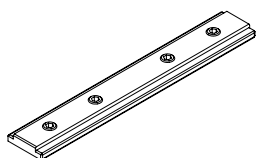

Profile connector V407, white plastic 21956.20

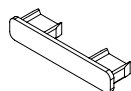

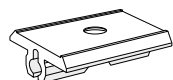

Side cap S502
Plastic, grey 21507.14

Plastic, white 21507.20



Clip for 2-channel profile HM-20502 21508.20

	Article description	Order no.
	<p>Topspan universal screw hex key, special head for white cap</p> <p>4.5 × 40 mm</p> <p>4.5 × 50 mm</p> <p>4.5 × 80 mm</p>	<p>55084</p> <p>55085</p> <p>55088</p>
	<p>Topspan cap 3.1 × 9.0 mm for Topspan screws</p> <p>Plastic, white</p>	<p>55091.20</p>
	<p><i>Clie</i> «sixo» “sixo” cross-bracket glider HC3 for profile channel width 5.8-6.2 mm</p>	<p>25503</p>
	<p><i>Clie</i> «sixo» “sixo” longitudinal bracket glider HC4 for profile channel width 5.8-6.2 mm</p>	<p>25504</p>

3- to 4-channel reversible rail with "maxi"/"sixo" track

HM-20503 / 504

3-Lauf
3 voies

4-Lauf
4 voies

Reversible rail for visible installation; can be used on both sides.

Profil.



Aluminium, natural anodised

Aluminium, white, RAL 9016

Stock lengths of 6 m

"maxi" accessories

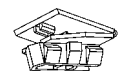

Installation accessories

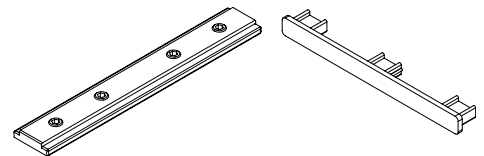
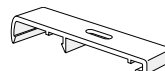
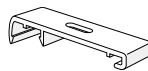

Services

Made-to-measure including opening/insert, countersunk drill holes and mitre

Bending service

This profile cannot be bent



Opening / glider entry is only possible with "midi" punch head.

Installation

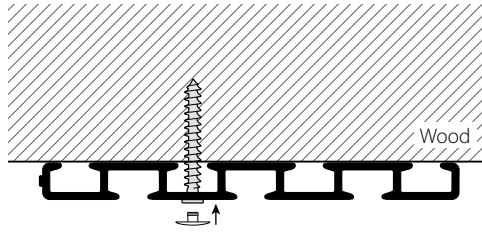

3-channel ceiling installation-

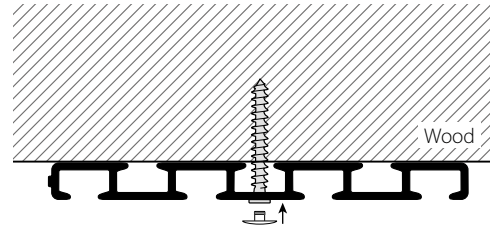

4-channel ceiling installation-

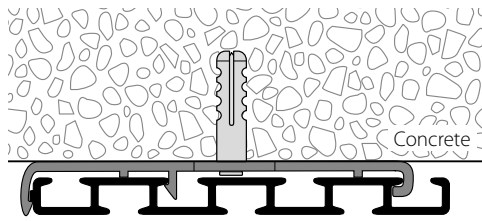

3-channel ceiling installation with clip bracket

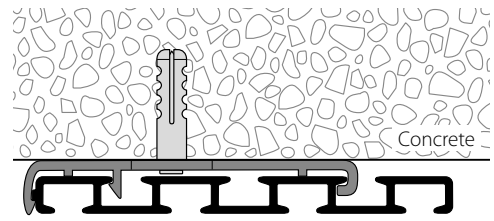

4-channel ceiling installation with clip bracket

Countersunk drill hole every 40-50 cm along profile, white cap



Ordering information:

Please state whether 3-channel HM-20503 or 4-channel HM-20504 is being used for drill holes.

Article description

Order no.

Reversible, can be used on both sides,
3-channel and reversible 4-channel

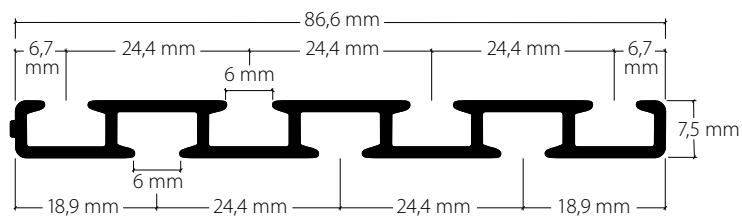

3-channel/4-channel

Aluminium, natural anodised

20503.10

3-channel/4-channel

Aluminium, white, RAL 9016

20503.20

Drill hole for Topspan
universal screw 4.5 x ...

95.20801



Stock lengths of 6 m

Made-to-measure + 20%

Opening / glider entry is only possible with "midi" punch head.

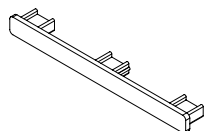

Side cap S503

Plastic, grey

21509.14



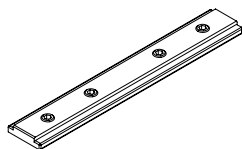

Plastic, white

21509.20

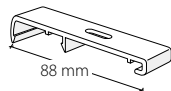
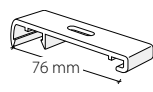

Profile connector V407, white plastic

21956.20

	Article description	Order no.
	<p>Topspan universal screw hex key, special head for white cap</p> <p>4.5 × 40 mm</p> <p>4.5 × 50 mm</p> <p>4.5 × 80 mm</p>	<p>55084</p> <p>55085</p> <p>55088</p>
	<p>Topspan cap 3.1 × 9.0 mm for Topspan screws</p> <p>Plastic, white</p>	<p>55091.20</p>
	<p>Clip bracket for 3-channel use</p> <p>Plastic, grey</p> <p>Plastic, white</p>	<p>21506.14</p> <p>21506.20</p>
	<p>Clip bracket for 4-channel use</p> <p>Plastic, grey</p> <p>Plastic, white</p>	<p>21505.14</p> <p>21505.20</p>
	<p><i>«sixo»</i> “sixo” cross-bracket glider HC3 for profile channel width 5.8-6.2 mm</p>	<p>25503</p>
	<p><i>«sixo»</i> “sixo” longitudinal bracket glider HC4 for profile channel width 5.8-6.2 mm</p>	<p>25504</p>

Panel curtain profile system with "maxi" channel, 3-channel

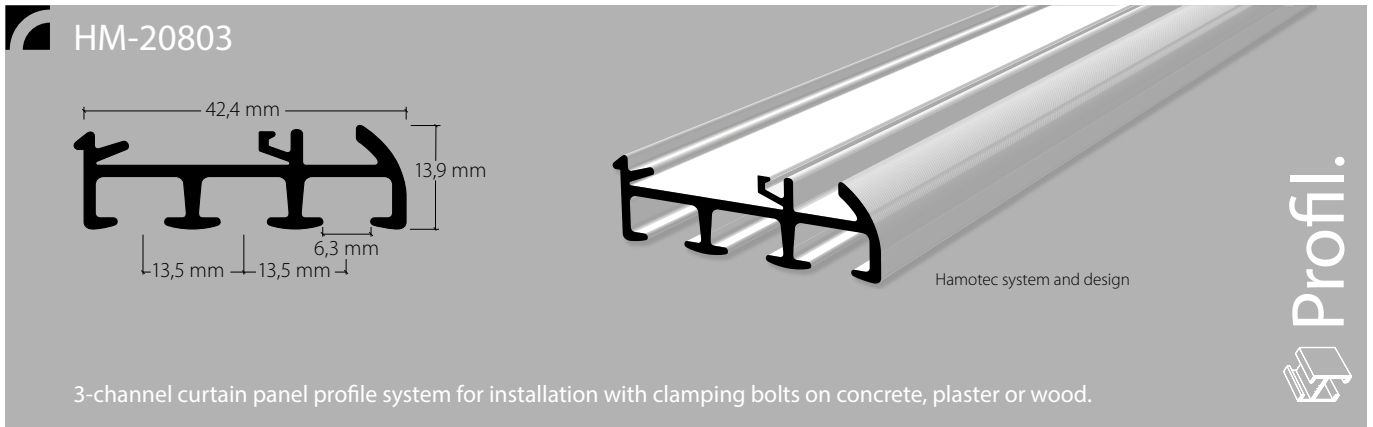

Aluminium, natural anodised

Aluminium, white, RAL 9016

Stock lengths of 4 m and 6 m

"maxi" accessories

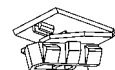

Installation accessories

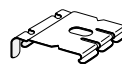
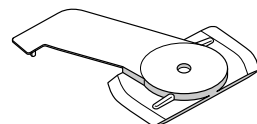
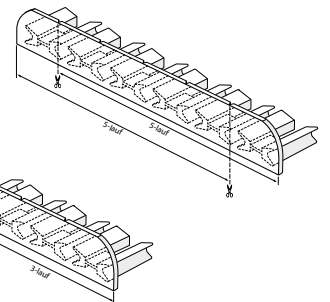
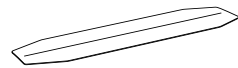
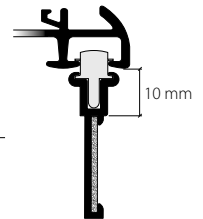
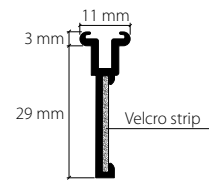
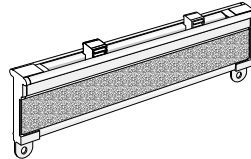
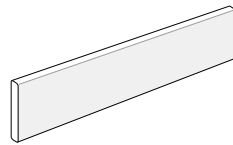

Services

Made-to-measure including opening/insert



This profile cannot be bent, but can be mitred.

Installation

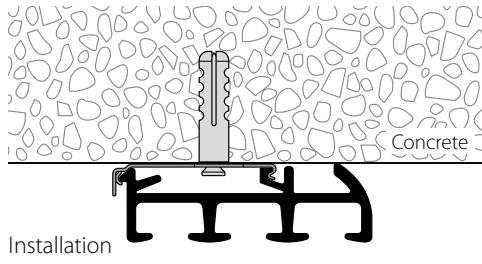

Clamping bolt

Clip

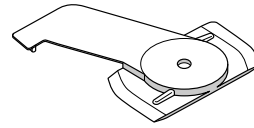

Fixings approx. every 40-50 cm

Wall installation with Rail-Line bracket

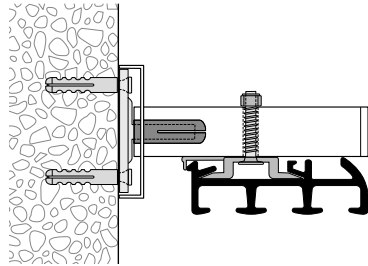
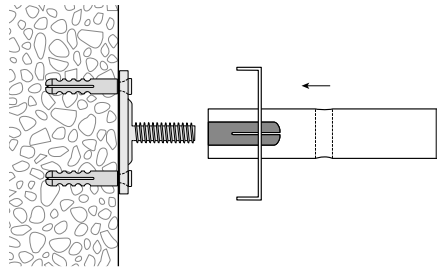

Article description	Order no.
---------------------	-----------

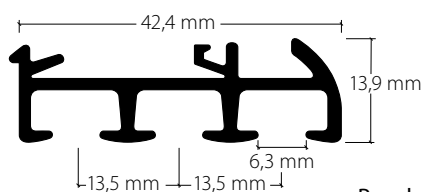

Panel curtain profile system with "maxi" channel, 3-channel

Aluminium, natural anodised

20803.10

Aluminium, white, RAL 9016

20803.20



Stock lengths of 4 m and 6 m

Made-to-measure + 20%

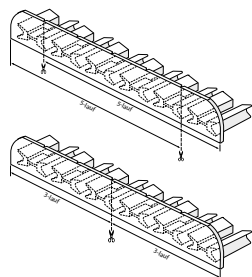

Side cap S20803/S20805
for panel curtain rail HM-20803/20805

Plastic, grey

21030.14

Plastic, white

21030.20

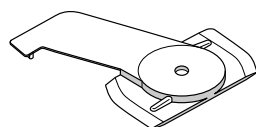

Installation of clamping bolt, white plastic
for panel curtain rails HM-20803/813

21031.20



Installation clip, metal
for panel curtain rails HM-20803/813

21033



Profile connector, metal
for panel curtain rails HM-20803/813

21018

Article description

Order no.



Rail-Line wall bracket, aluminium, undrilled
including bracket cap, wall cover, installation plate,
brass sleeve, fully assembled

Projection up to

Matt aluminium	7 cm	21431.12
	10 cm	21432.12
	15 cm	21434.12
Aluminium, white	7 cm	21431.20
	10 cm	21432.20
	15 cm	21434.20

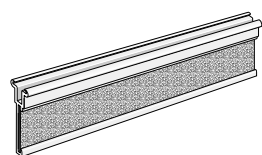

Carrier, aluminium, white
with hook strip on piping
for Hamotec-Line panel curtain system

21604.20

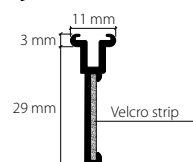

Stock lengths of 3 m

Made-to-measure + 20%

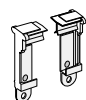

**Side cap, white plastic
for panel carrier**
with eyelet for sliding rod

21618.20

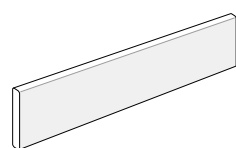
**Flat profile 30 x 5 mm**

Aluminium, natural anodised

21696.10

Aluminium, white, RAL 9016

21696.20



Stock lengths of 3 m

Made-to-measure + 20%

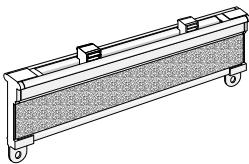
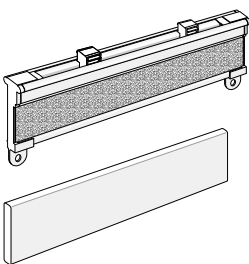
	Article description	Order no.
	<p>Carrier, aluminium, white, fully assembled with side cap 21618.20 made-to-measure (from 80 cm with 3 Clic gliders)</p>	<p>21651.20 21653.20 21655.20 21657.20 21659.20 21661.20 21663.20 21665.20 21667.20 21669.20 21671.20</p>
	<p>Carrier, aluminium, white, fully assembled including flat profile 30 x 5 mm white made-to-measure (from 80 cm with 3 Clic gliders) for the Hamotec panel curtain system</p>	<p>21634.20 21635.20 21636.20 21637.20 21638.20 21639.20 21640.20 21641.20 21642.20 21643.20 21644.20</p>

Panel curtain profile system with "maxi" channel, 5-channel

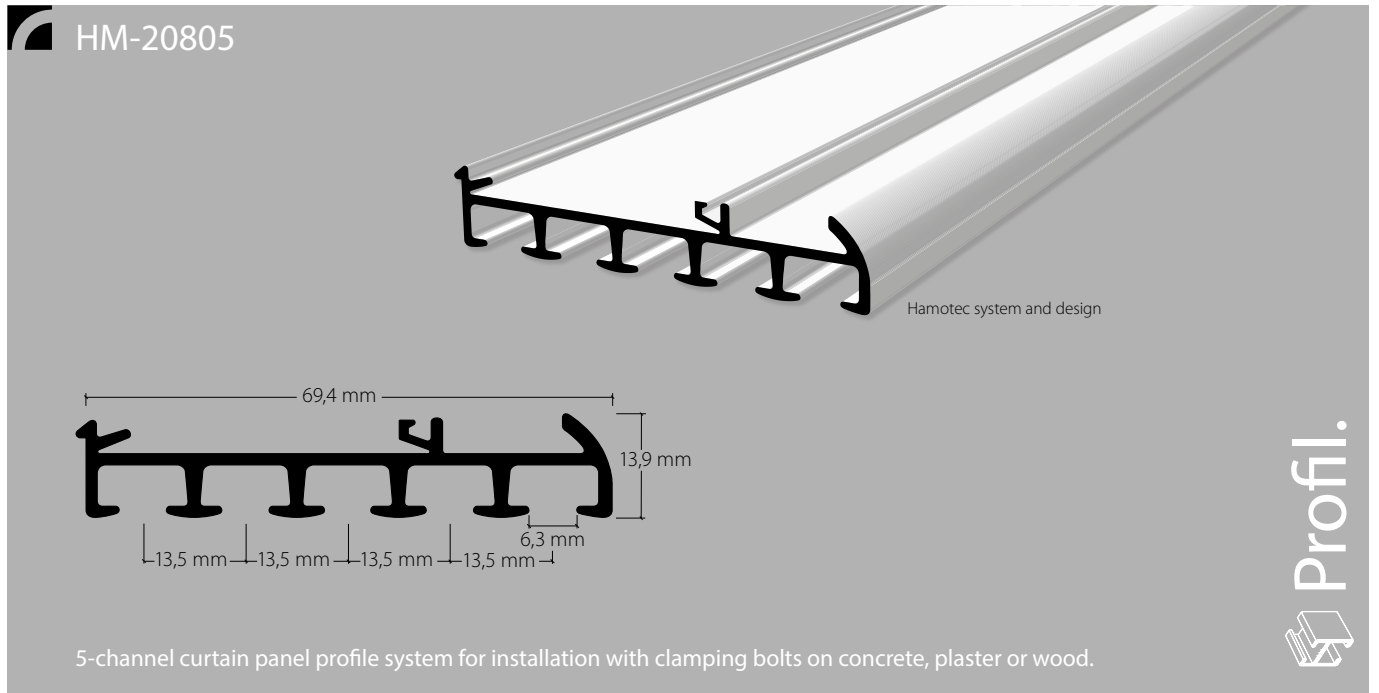

5-channel curtain panel profile system for installation with clamping bolts on concrete, plaster or wood.



Aluminium, natural anodised

Aluminium, white, RAL 9016

Stock lengths of 4 m and 6 m

"maxi" accessories

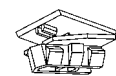

Installation accessories

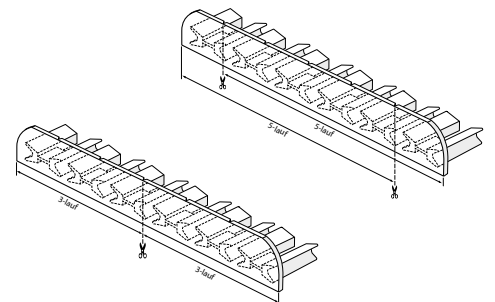
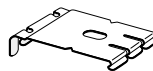
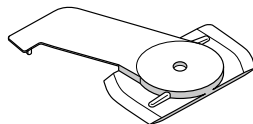
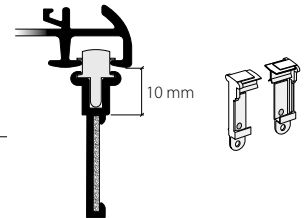
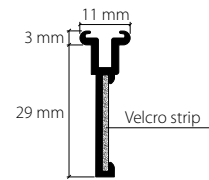
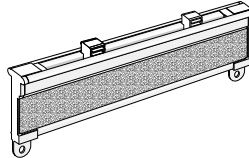
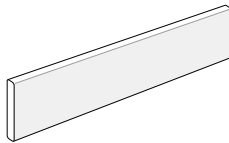

Services

Made-to-measure including opening/insert



This profile cannot be bent, but can be mitred.

Installation

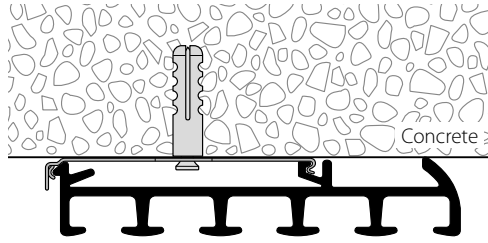

Installation

Clamping bolt

Clip

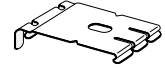
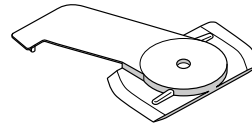

Fixings approx. every 40-50 cm

Wall installation with Rail-Line bracket

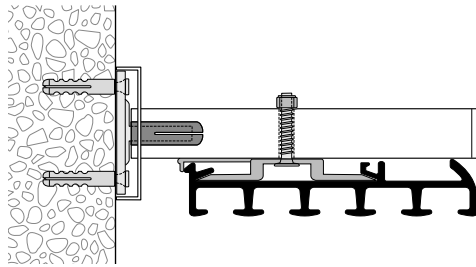
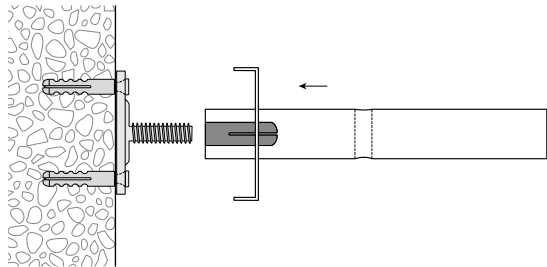

Article description	Order no.
---------------------	-----------

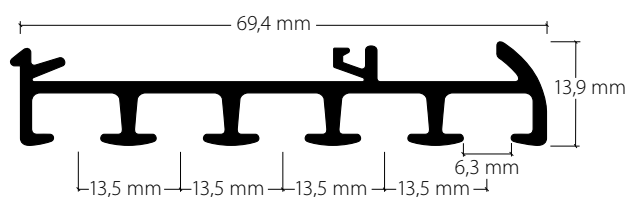

Panel curtain profile system with "maxi" channel, 5-channel

Aluminium, natural anodised 20805.10

Aluminium, white, RAL 9016 20805.20



Stock lengths of 4 m and 6 m

Made-to-measure + 20%

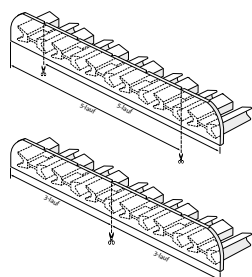

Side cap S20803/S20805
for panel curtain rail HM-20803/20805

Plastic, grey 21030.14

Plastic, white 21030.20

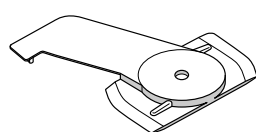

Installation of clamping bolt, white plastic
for panel curtain rails HM-20805/815 21039.20



Installation clip, metal
for panel curtain rails HM-20805/815 21035

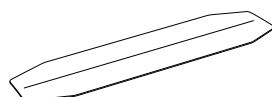

Profile connector, spring steel
for panel curtain rails HM-20805/815 21028

Article description

Order no.



Rail-Line wall bracket, aluminium, undrilled
including bracket cap, wall cover, installation plate,
brass sleeve, fully assembled

Projection up to

Matt aluminium	7 cm	21431.12
	10 cm	21432.12
	15 cm	21434.12
Aluminium, white	7 cm	21431.20
	10 cm	21432.20
	15 cm	21434.20

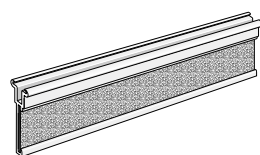

Carrier, aluminium, white
with hook strip on piping
for Hamotec-Line panel curtain system

21604.20

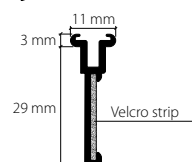

Stock lengths of 3 m

Made-to-measure + 20%



**Side cap, white plastic
for panel carrier**
with eyelet for sliding rod

21618.20

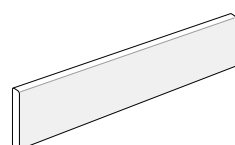
**Flat profile 30 x 5 mm**

Aluminium, natural anodised

21696.10

Aluminium, white, RAL 9016

21696.20



Stock lengths of 3 m

Made-to-measure + 20%

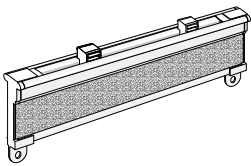
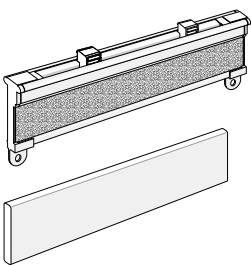
	Article description	Order no.
	<p>Carrier, aluminium, white, fully assembled with side cap 21618.20, made-to-measure (from 80 cm with 3 Clic gliders)</p>	<p>21651.20 21653.20 21655.20 21657.20 21659.20 21661.20 21663.20 21665.20 21667.20 21669.20 21671.20</p>
	<p>Carrier, aluminium, white, fully assembled including flat profile 30 x 5 mm white made-to-measure (from 80 cm with 3 Clic gliders) for the Hamotec panel curtain system</p>	<p>21634.20 21635.20 21636.20 21637.20 21638.20 21639.20 21640.20 21641.20 21642.20 21643.20 21644.20</p>

Panel curtain profile system with "maxi" channel, 3-channel

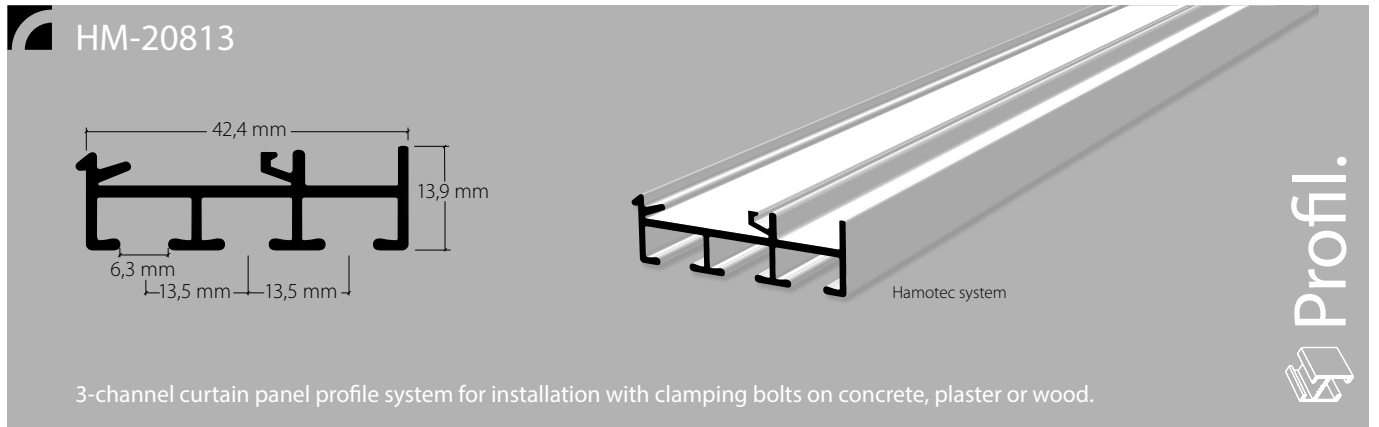

Aluminium, natural anodised

Aluminium, white, RAL 9016

Stock lengths of 4 m and 6 m

"maxi" accessories



Installation accessories

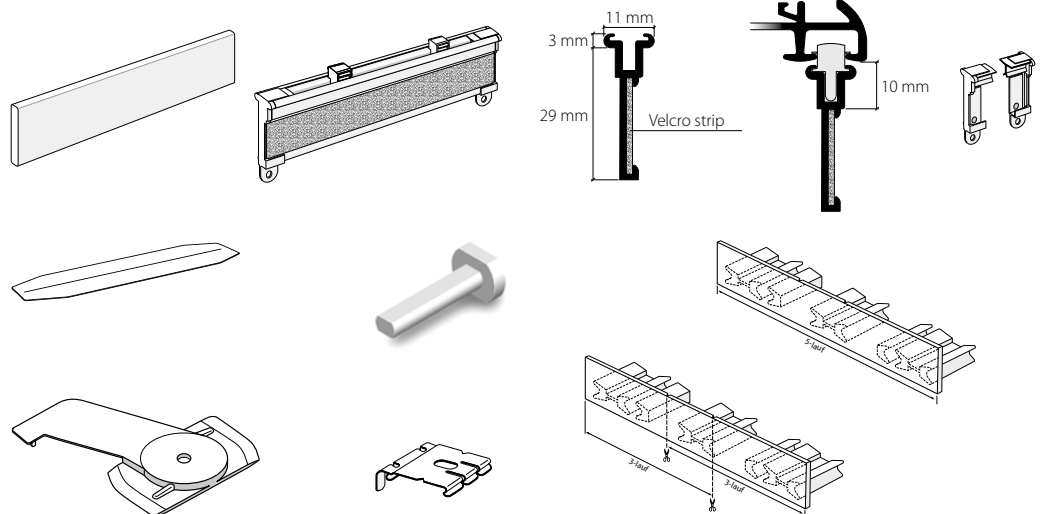

Services

Made-to-measure including opening/insert



This profile cannot be bent, but can be mitred.

Installation

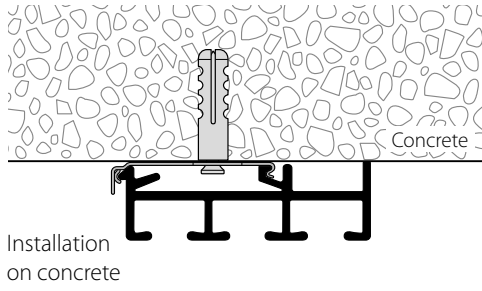

Clamping bolt

Clip

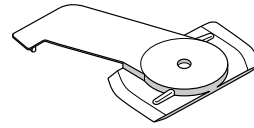

Fixings approx. every 40-50 cm

Wall installation with Rail-Line bracket

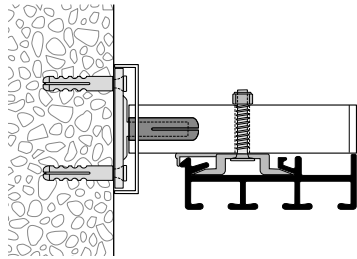
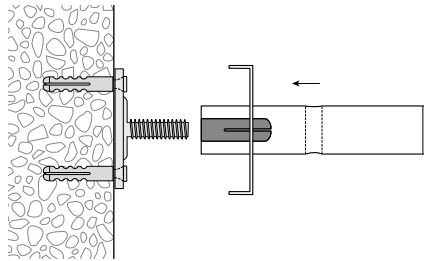

Article description	Order no.
---------------------	-----------

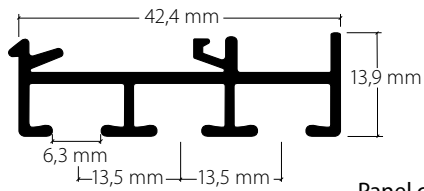

Panel curtain profile system with "maxi" channel, 3-channel

Aluminium, natural anodised 20813.10

Aluminium, white, RAL 9016 20813.20



Stock lengths of 4 m and 6 m

Made-to-measure + 20%

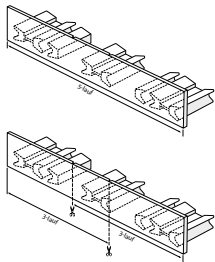

Side cap S20813/S20815
for panel curtain rail HM-20813/20815

Plastic, grey 21034.14

Plastic, white 21034.20

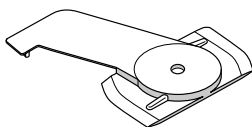

Installation of clamping bolt, white plastic 21031.20
for panel curtain rails HM-20803/813



Installation clip, metal 21033
for panel curtain rails HM-20803/813

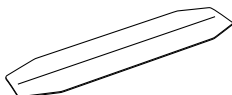

Profile connector, metal 21018
for panel curtain rails HM-20803/813

Article description

Order no.



Rail-Line wall bracket, aluminium, undrilled
including bracket cap, wall cover, installation plate,
brass sleeve, fully assembled

Projection up to

Matt aluminium	7 cm	21431.12
	10 cm	21432.12
	15 cm	21434.12
Aluminium, white	7 cm	21431.20
	10 cm	21432.20
	15 cm	21434.20

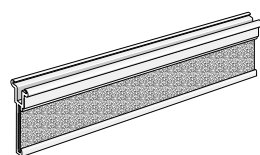

Carrier, aluminium, white
with hook strip on piping
for Hamotec-Line panel curtain system

21604.20

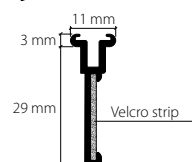

Stock lengths of 3 m

Made-to-measure + 20%

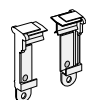

**Side cap, white plastic
for panel carrier**
with eyelet for sliding rod

21618.20

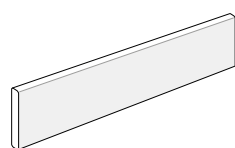
**Flat profile 30 x 5 mm**

Aluminium, natural anodised

21696.10

Aluminium, white, RAL 9016

21696.20



Stock lengths of 3 m

Made-to-measure + 20%

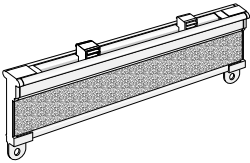
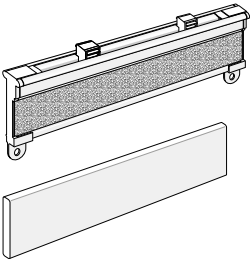
	Article description	Order no.
	Carrier, aluminium, white, fully assembled with side cap 21618.20 made-to-measure (from 80 cm with 3 Clic gliders)	21651.20 21653.20 21655.20 21657.20 21659.20 21661.20 21663.20 21665.20 21667.20 21669.20 21671.20
	Carrier, aluminium, white, fully assembled including flat profile 30 x 5 mm white made-to-measure (from 80 cm with 3 Clic gliders) for the Hamotec panel curtain system	21634.20 21635.20 21636.20 21637.20 21638.20 21639.20 21640.20 21641.20 21642.20 21643.20 21644.20

Panel curtain profile system with "maxi" channel, 5-channel

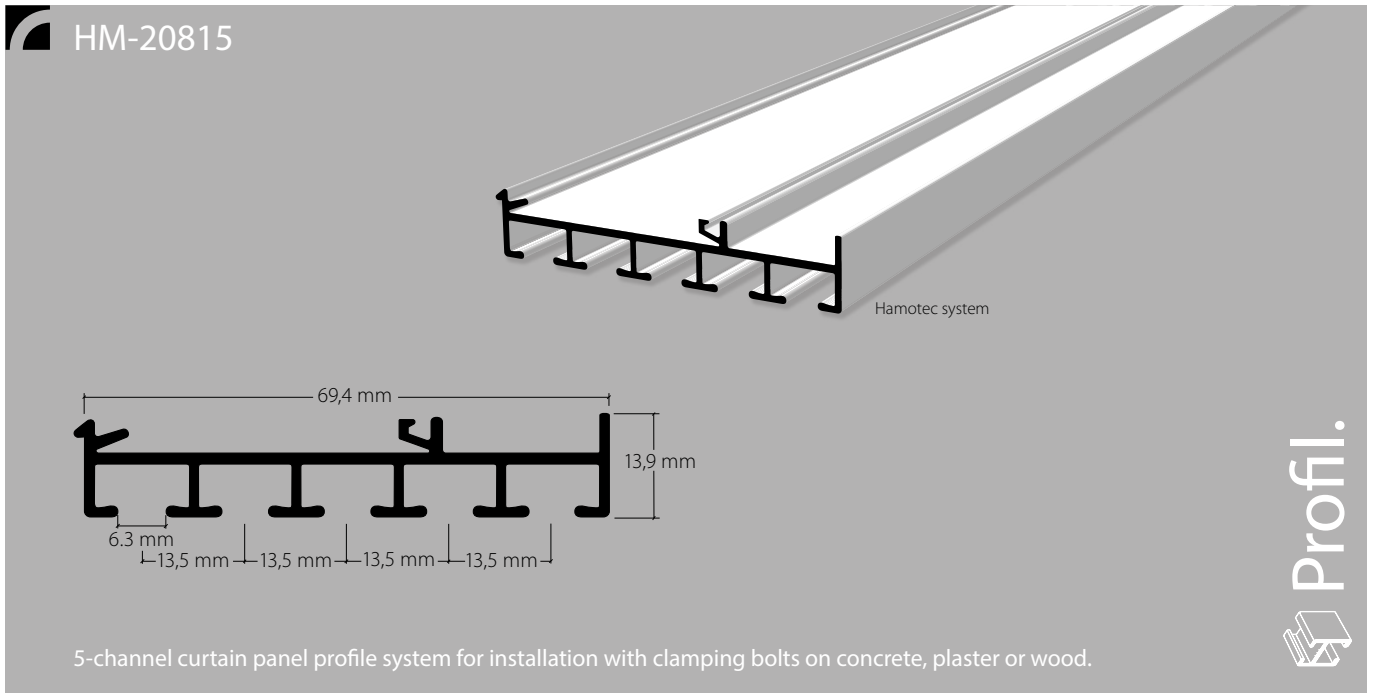

Aluminium, natural anodised

Aluminium, white, RAL 9016

Stock lengths of 4 m and 6 m

"maxi" accessories

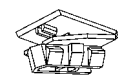

Installation accessories

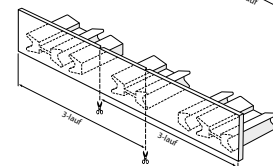
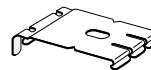
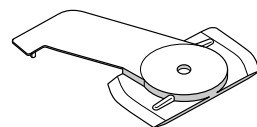
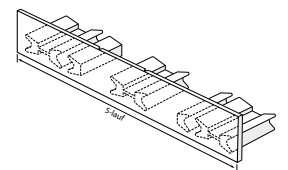
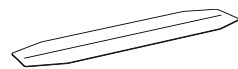
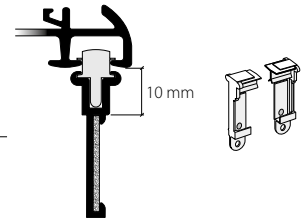
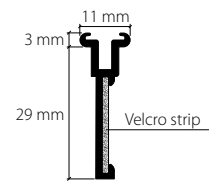
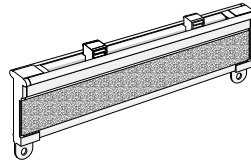
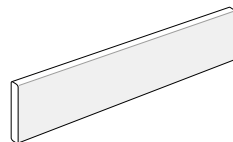

Services

Made-to-measure including opening/insert



This profile cannot be bent, but can be mitred.

Installation

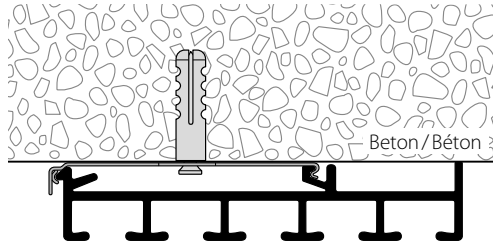

Installation on concrete

Clamping bolt

Clip

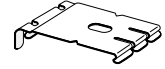
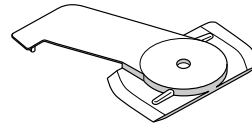

Fixings approx. every 40-50 cm

Wall installation with Rail-Line bracket

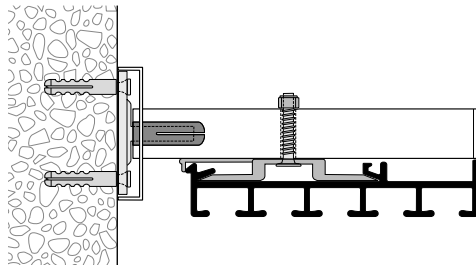
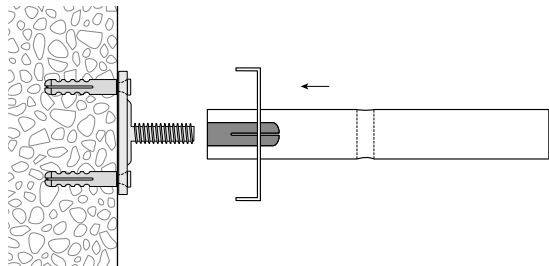

Article description	Order no.
---------------------	-----------

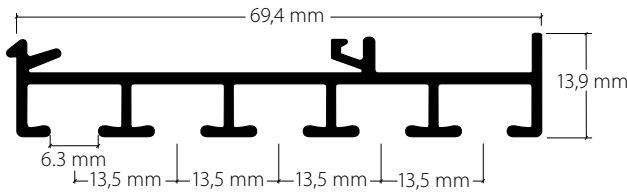

Panel curtain profile system with "maxi" channel, 5-channel

Aluminium, natural anodised 20815.10

Aluminium, white, RAL 9016 20815.20



Stock lengths of 4 m and 6 m

Made-to-measure + 20%

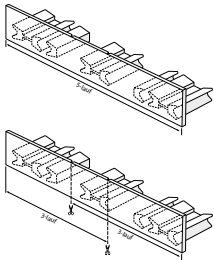

Side cap S20813/S20815
for panel curtain rail HM-20813/20815

Plastic, grey 21034.14

Plastic, white 21034.20

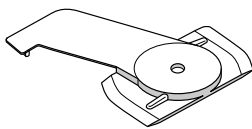

Installation of clamping bolt, white plastic
for panel curtain rails HM-20805/815 21039.20



Installation clip, metal
for panel curtain rails HM-20805/815 21035

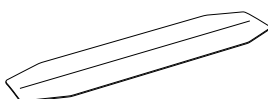

Profile connector, spring steel
for panel curtain rails HM-20805/815 21028

Article description

Order no.



Rail-Line wall bracket, aluminium, undrilled
including bracket cap, wall cover, installation plate,
brass sleeve, fully assembled

Projection up to

Matt aluminium	7 cm	21431.12
	10 cm	21432.12
	15 cm	21434.12
Aluminium, white	7 cm	21431.20
	10 cm	21432.20
	15 cm	21434.20

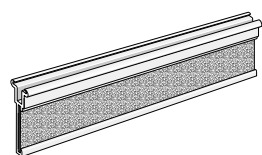

Carrier, aluminium, white
with hook strip on piping
for Hamotec-Line panel curtain system

21604.20

30 m
60 m
120 m
240 m

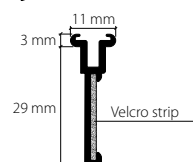

Stock lengths of 3 m

Made-to-measure + 20%



**Side cap, white plastic
for panel carrier**
with eyelet for sliding rod

21618.20

25 pair
50 pair
100 pair

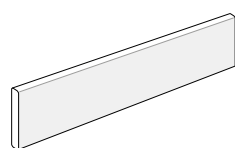
**Flat profile 30 x 5 mm**

Aluminium, natural anodised

21696.10

30 m
60 m
120 m

Aluminium, white, RAL 9016

21696.20

30 m
60 m
120 m



Stock lengths of 3 m

Made-to-measure + 20%

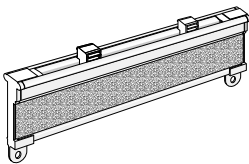
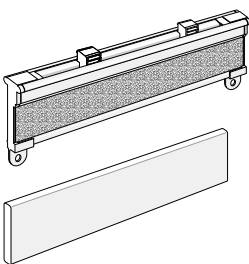
	Article description	Order no.
	<p>Carrier, aluminium, white, fully assembled with side cap 21618.20 made-to-measure (from 80 cm with 3 Clic gliders)</p>	<p>21651.20 21653.20 21655.20 21657.20 21659.20 21661.20 21663.20 21665.20 21667.20 21669.20 21671.20</p>
	<p>Carrier, aluminium, white, fully assembled including flat profile 30 x 5 mm white made-to-measure (from 80 cm with 3 Clic gliders) for the Hamotec panel curtain system</p>	<p>21634.20 21635.20 21636.20 21637.20 21638.20 21639.20 21640.20 21641.20 21642.20 21643.20 21644.20</p>