

HAMOTEC

Curtain profile systems for **embedding in concrete**
for indoors and outdoors

4





Profil.

Curtain profile systems for embedding in concrete for indoors and outdoors

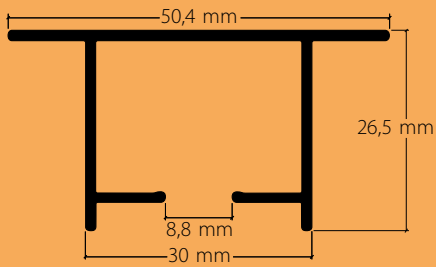

HM-20110
Seite / page 1

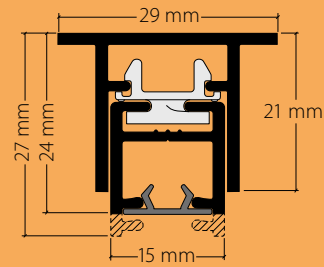

HM-20112 «maxi»
Seite / page 7

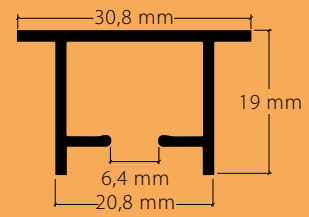

HM-20115 «maxi»
Seite / page 13

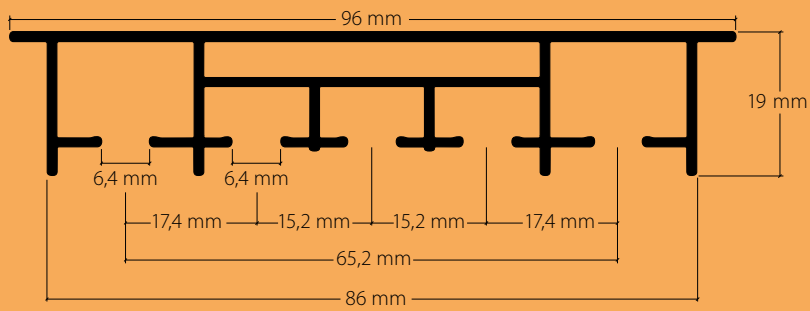

HM-20117 «maxi»
Seite / page 19



Profil.

Balcony curtain profile for embedding in concrete

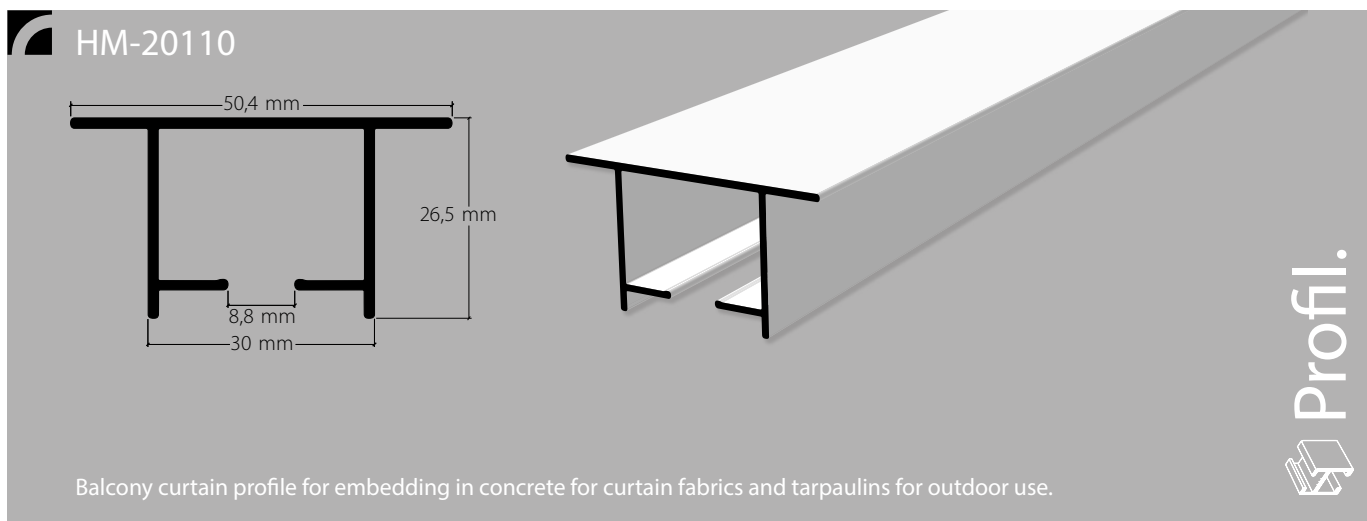

Aluminium, grey, RAL 7038

Aluminium, white, RAL 9016

Stock lengths of 6 m

Accessories

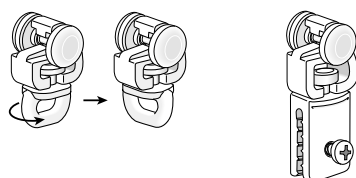

Installation accessories

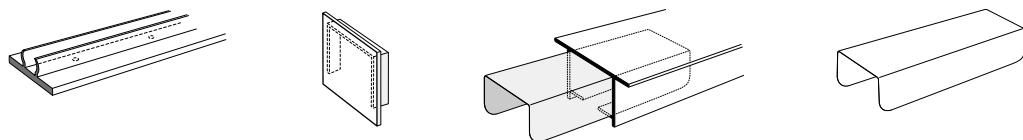

Services

Made-to-measure

Bending service

Plan view (seen from above). State room side.



Radii: from 300 mm
90° angle or angle of your choice



Non-standard radii and angles as per sketch

Installation instructions, see next page

Installation

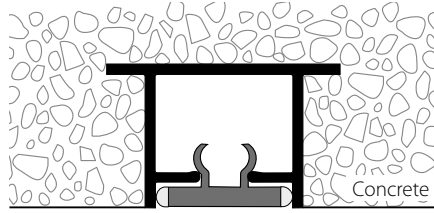
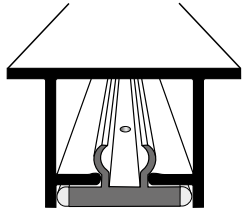

1. Treat the curtain profile HM-20110 (HM-20115) with silicone spray.



2. Insert movable protective tape into the curve of the curtain profile.

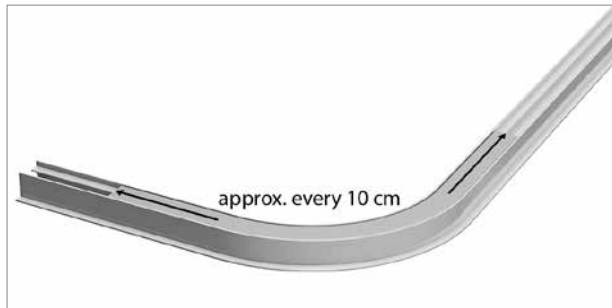

3. The protective strip should reach approx. 10 cm into the straight.

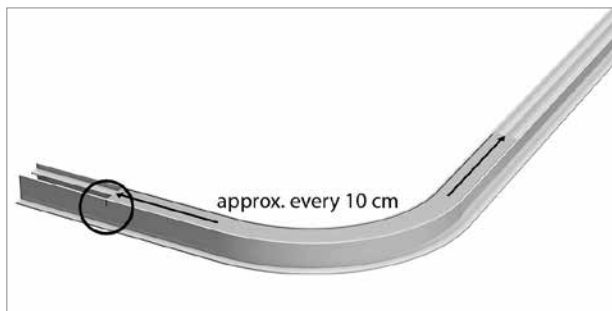

4. Mark the side of the strip end.



5. Seal the curtain profile with the side cap 21052 (HM-20115 with 21053) (to prevent the ingress of concrete water).

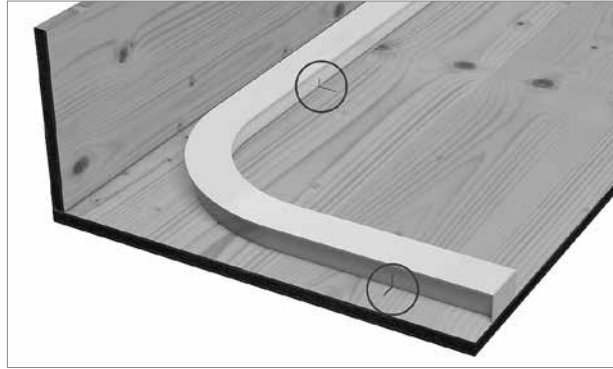

6. Adjust curtain profile to marking and mark tape end on panel.

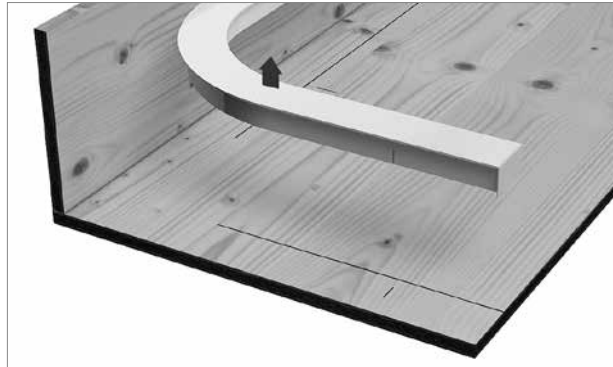

7. Remove the curtain profile once more.

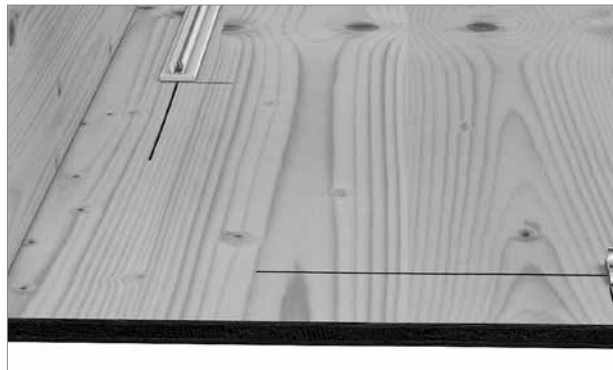

8. Fix pre-drilled installation strips to marking with Hamotec special nails.

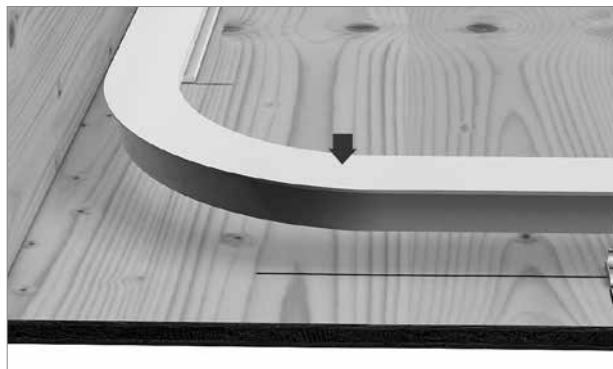

9. Clip the curtain profile onto the installation strip.

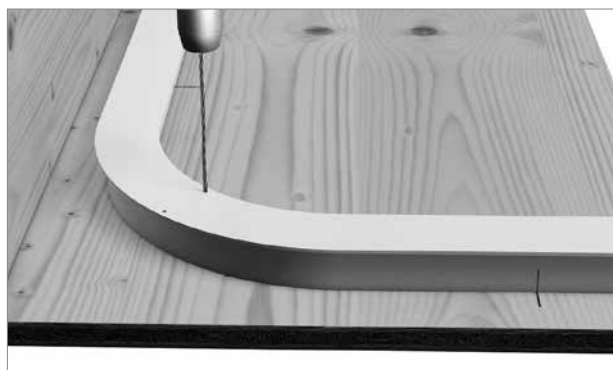

10. Drill two side holes into the curve of the profile.

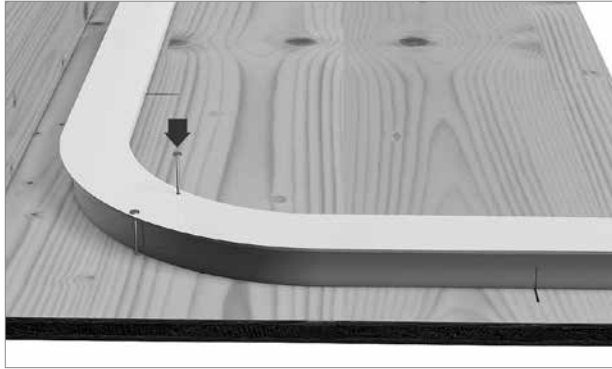

11. Fix the curtain profile to the panel using aluminium nails.



12. Concrete in the profile.

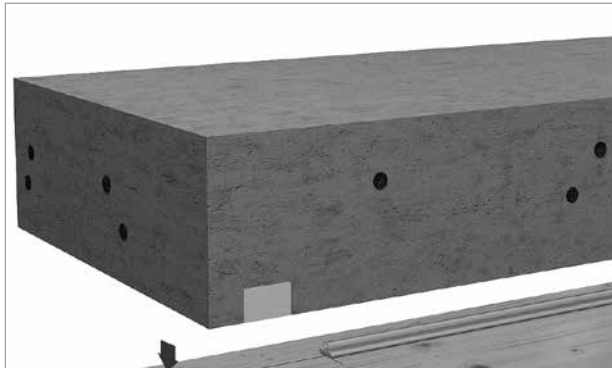

13. Remove the panel once hardened.

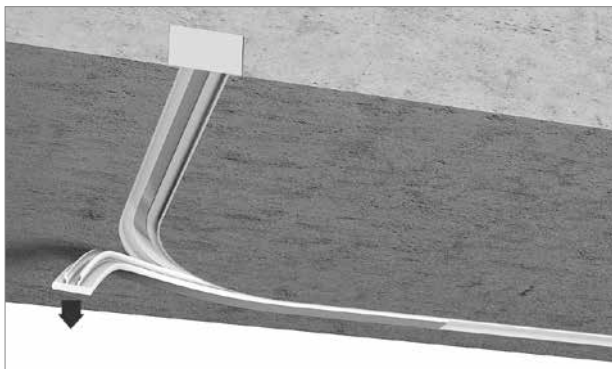

14. Remove the remaining protective strip.

Caution:

It is **essential** that you re-insert the protective strip if the ceiling still needs to be painted or use another means to protect it!

Article description	Order no.
---------------------	-----------

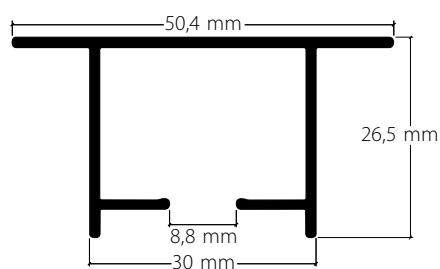

Balcony curtain profile for embedding in concrete
for curtain fabrics and tarpaulin as privacy
and sun screen

Aluminium, grey, RAL 7038

20110.11

Aluminium, white, RAL 9016

20110.20



Stock lengths of 6 m

Made-to-measure + 20%

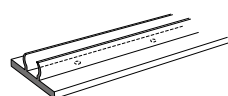

Cover strip L110, white plastic
drilled 2.0 mm

21049.20



Stock lengths of 6 m

Made-to-measure + 20%

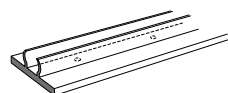

Cover strip L110, plastic SOFT
(for curved elements)
for balcony profile HM-20110 drilled Ø 2.0 mm

21049.20.W



Stock lengths of 2 m

Made-to-measure + 20%

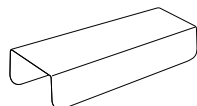





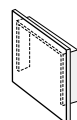

Profile connector V110, spring steel

21220

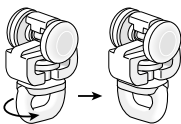

Side cap S20110, grey plastic
prevents the ingress of concrete water

21052.14

	Article description	Order no.
	Aluminium nails 3.1 x 55 mm Box contains 500 <i>Clous en aluminium 3,1 x 55 mm</i> <i>Cartons de 500 pcs</i>	991105
	Double head pin 1.6 x 24/ 35 mm 2.0 x 24/ 32 mm 2.0 x 24/ 32 mm, grooved	991102 991106 991107
	Locking device C110, nickel-plated iron	25200 50 pc.
	Roller, metal, with clamping eyelet for balcony profile HM-20110 and 20150 Plastic, grey Plastic, white	21210.14 21210.20
	Eyelet roller with rotating sewn eyelet for balcony profile HM-20110 and 20150 Plastic, grey Plastic, white	21211.14 21211.20
Bending service	Plan view (seen from above). State room side.  Radii: from 300 to 1000 mm 90° angle or angle of your choice  Non-standard radii and angles as per sketch	95.20110.1 95.20110.4

Curtain rail system for embedding in concrete with "maxi" channel

System set HM-20112, VS57 standard

Installation set 20112 for curtain profile for embedding in concrete with curtain rail HM-20121 / 20123 flush-mounted, suitable for use with accessories VS57 also with eyelet roller.

Profil.

Curtain profile 20121 / 20123
Aluminium, white, RAL 9016

Basic profile 20120
Aluminium, grey, RAL 7038

Stock lengths of 6 m

"maxi" accessories

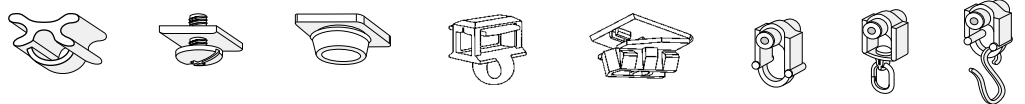

Installation accessories

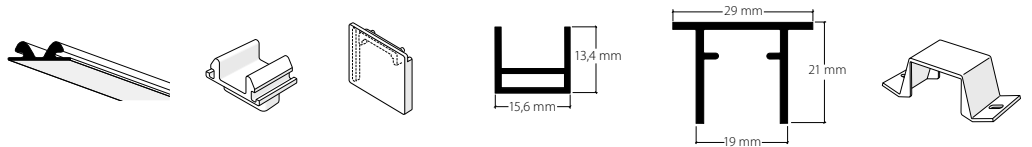

Installation

Plaster depth required **3 mm** with profile HM-20121

Plaster depth required **6 mm** with profile HM-20123

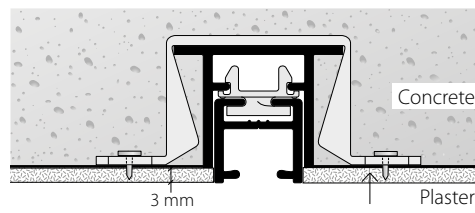

Installation with HM-20121, profile height 14.7 mm

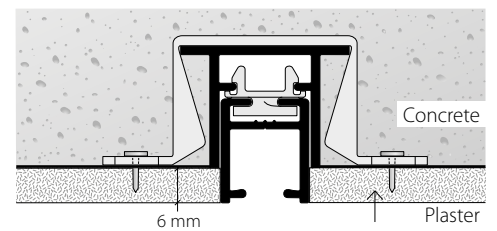

Installation with HM-20123, profile height 17.7 mm

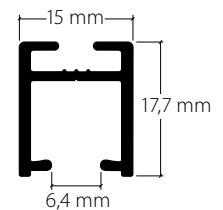
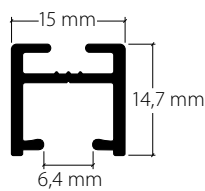

Installation instructions

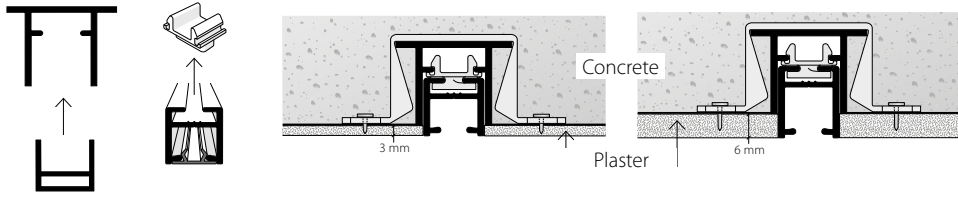

1. Treat the U-concrete protection profile HM-20122 with silicone spray and then insert into the basic profile HM-20120.

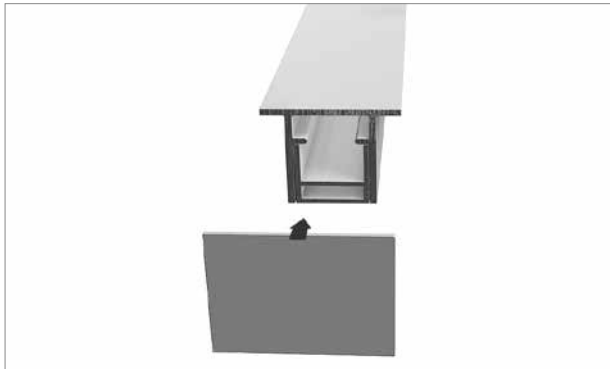

2. Use side cap 21069 to seal at the sides.

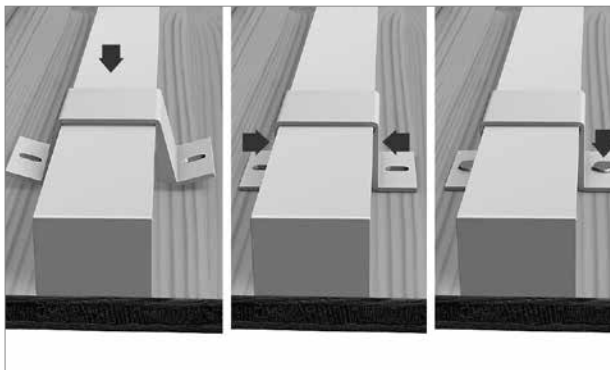

3. Fix the U-concrete protection profile HM-20122 with the basic profile HM-20120 to the panel using clip 21067. Use aluminium nails to fix the clip in place.



4. Position a clip every 30 cm.



5. Concrete in the profile.

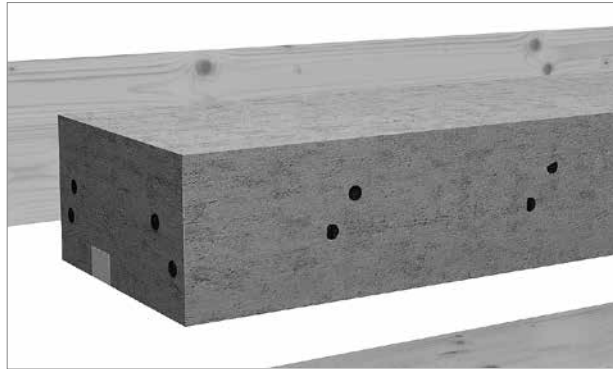

6. Remove the panels once hardened.

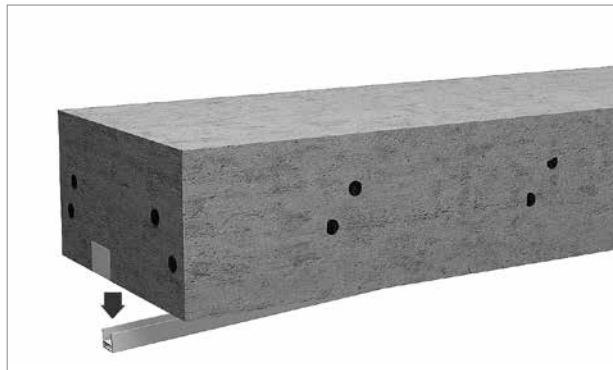

7. Remove the concrete protection profile (U-profile).

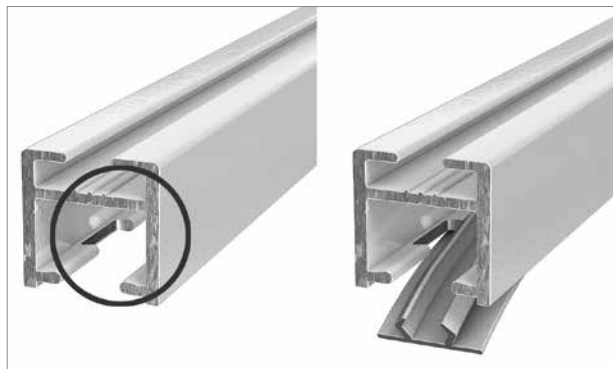

8. Provide the curtain profile HM-20121 (or HM-20123) with a glider entry (opening). Insert the cover strip (plaster protective strip 11055).

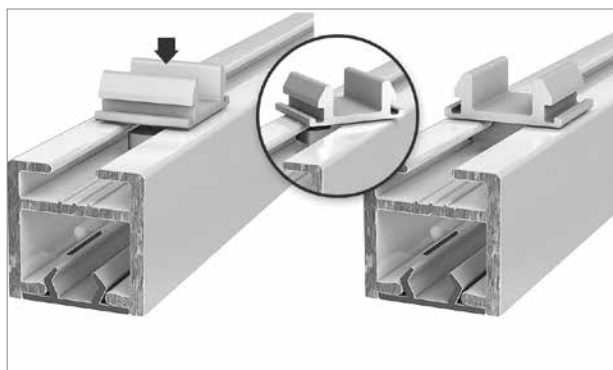

9. Turn the clip bracket 21068 into the profile.

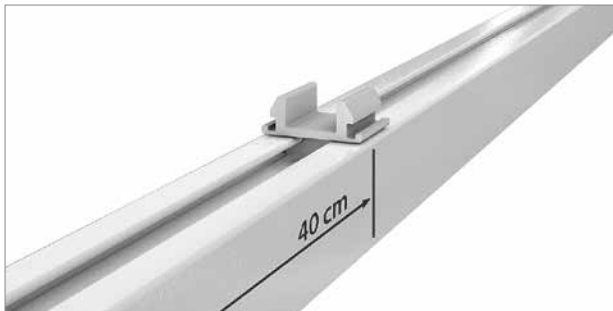

10. Place a clip bracket every 40 cm.

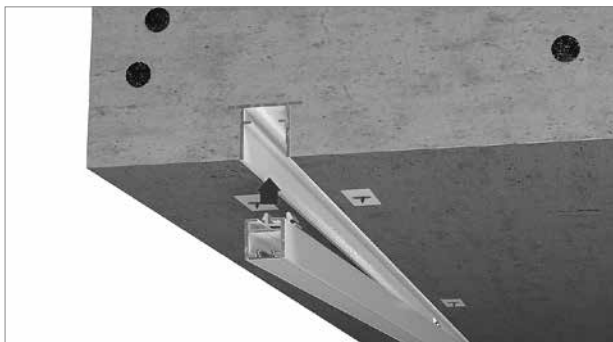

11. Click curtain profile HM-20121 (for 3 mm plaster cover) or HM-20123 (for 6 mm plaster cover) into the basic profile.

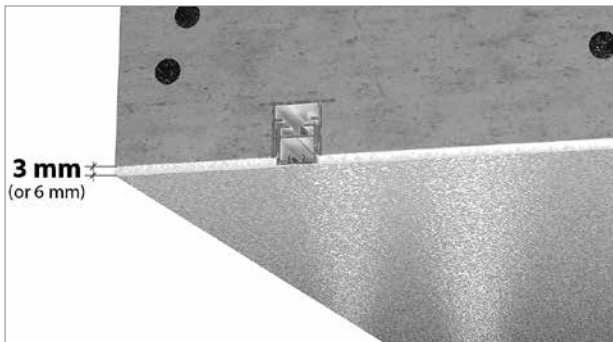

12. Plaster in the ceiling.



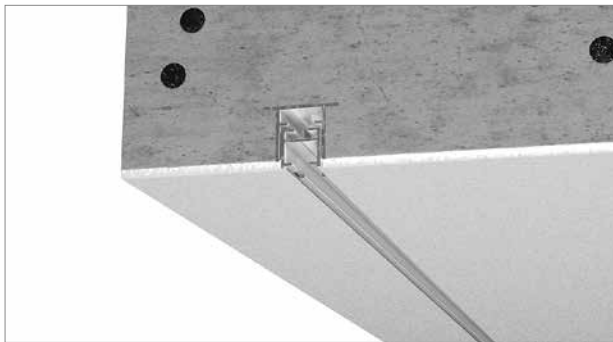

13. Remove the strip when the plaster is still wet.



14. You're done.

Caution:

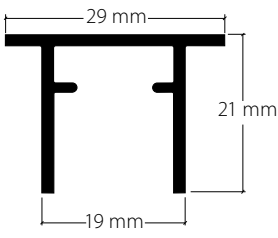
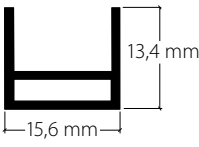
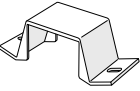
It is **essential** that you re-insert the protective strip if the ceiling still needs to be painted or use another means to protect it!

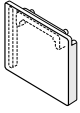
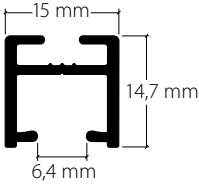
	Article description	Order no.
	<p>Basic profile for embedding in concrete, system 20112 Support profile for curtain profile HM-20121 and HM-20123</p> <p>Aluminium, grey, RAL 7038</p>	<p>20120.11</p>
<p>Stock lengths of 6 m</p>		
	<p>U-profile concrete protection profile, system 2011220122.00 15.6 x 13.4 mm, unfinished aluminium</p>	
<p>Stock lengths of 6 m</p>		
	<p>Clip fixing, plastic, system 20112 for anchor basic profile HM-20120 without the need for aluminium nails 991103</p>	<p>21067</p>
	<p>Aluminium nails 3.35 x 27 mm Box contains 500</p>	<p>991103</p>
	<p>Side closure S20112, plastic to seal the basic profile HM-20120</p>	<p>21069</p>
	<p>"maxi" curtain profile, VS57 standard for installation of system 20112 embedded in concrete</p> <p>Aluminium, white, RAL 9016</p>	<p>20121.20</p>
<p>Stock lengths of 6 m</p>		

Article description

Order no.

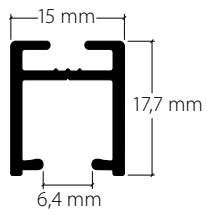

"maxi" curtain profile, VS57 standard
for installation of system 20112 embedded in concrete

Aluminium, white, RAL 9016

20123.20

Stock lengths of 6 m

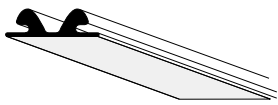

Plaster protection strip, white plastic

11055.20

60 m rolls

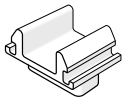

Clip bracket, plastic, to turn
into curtain profile HM-20121 or HM-20123

21068

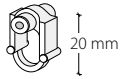

Eyelet roller
with shaft

25287

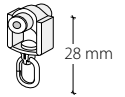

Eyelet roller
with rotatable eyelet

25288



Eyelet roller
with hook

25289

Bending service

Plan view (seen from above). State room side.



Radii: from 170 mm

95.20112.1

90° angle or angle of your choice



Non-standard radii and angles as per sketch

95.20112.4

“maxi” curtain profile for embedding in concrete, indoor use, VS57 standard

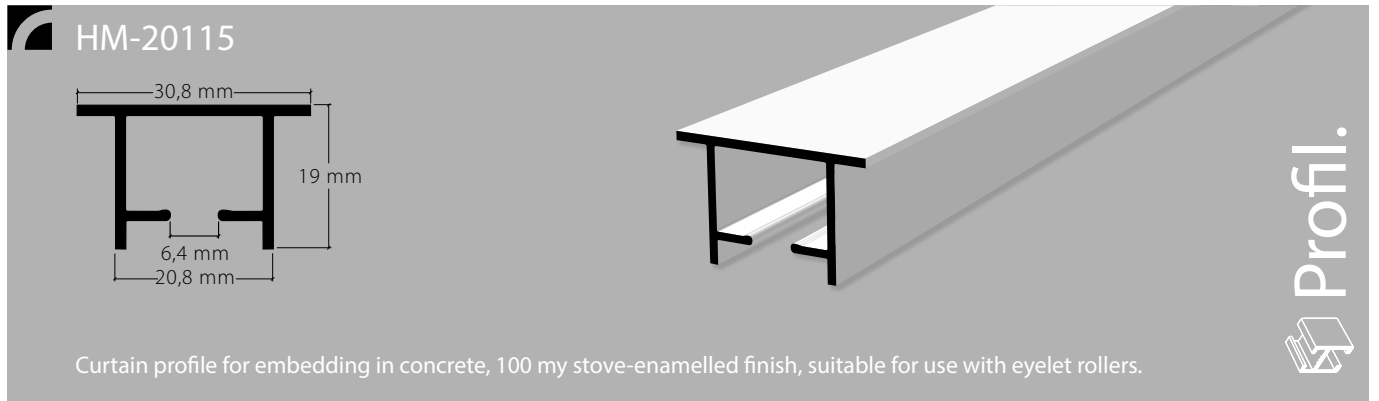

Aluminium RAL 7038/100 my grey

Aluminium RAL 9016/100 my white

Stock lengths of 6 m

“maxi” accessories

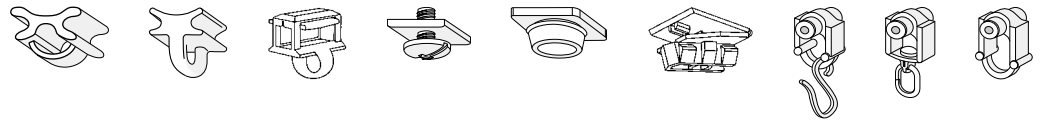

Installation accessories

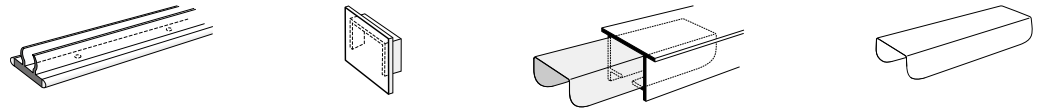

Services

Made-to-measure including opening/insert

Bending service

Plan view (seen from above). State room side.



Radii: from 250 mm
90° angle or angle of your choice



Non-standard radii and angles as per sketch

Installation instructions, see next page

Installation

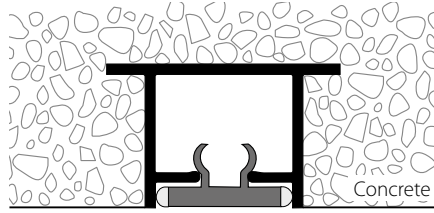
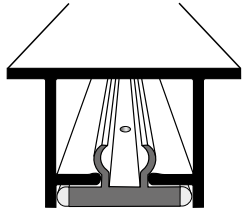

1. Treat the curtain profile HM-20110 (HM-20115) with silicone spray.



2. Insert movable protective tape into the curve of the curtain profile.

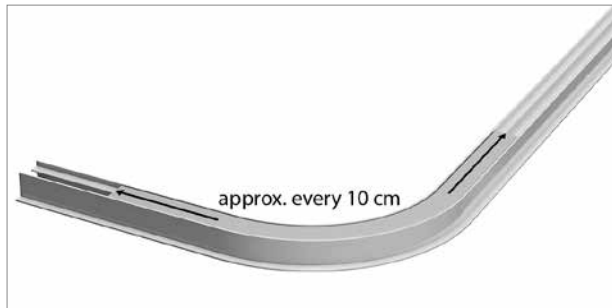

3. The protective strip should reach approx. 10 cm into the straight.

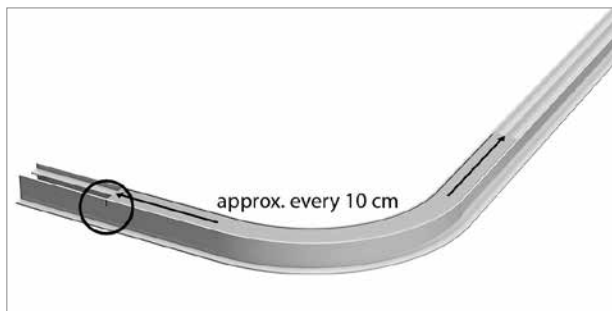

4. Mark the side of the strip end.



5. Seal the curtain profile with the side cap 21052 (HM-20115 with 21053) (to prevent the ingress of concrete water).

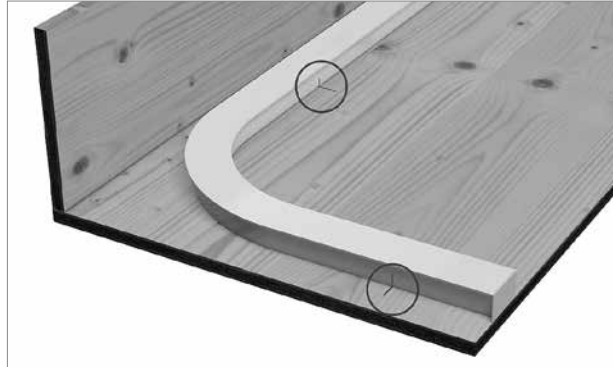

6. Adjust curtain profile to marking and mark tape end on panel.

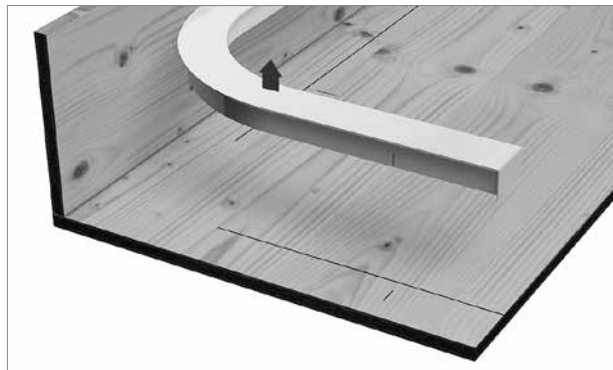

7. Remove the curtain profile once more.

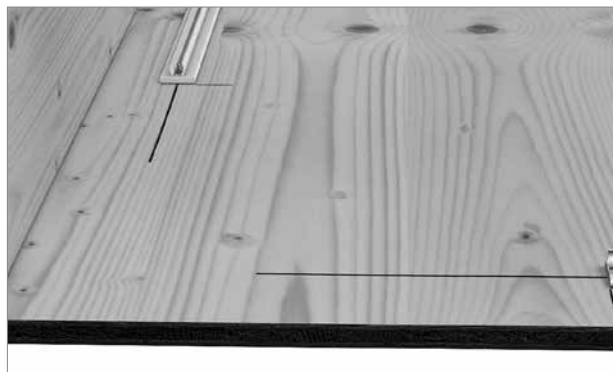

8. Fix pre-drilled installation strips to marking with Hamotec special nails.

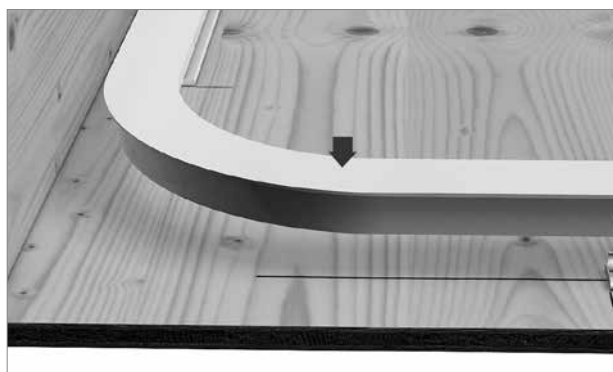

9. Clip the curtain profile onto the installation strip.

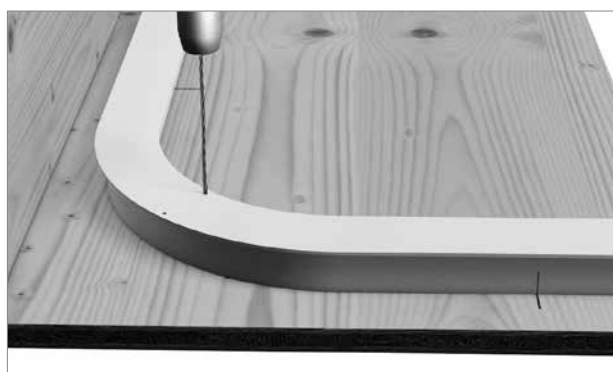

10. Drill two side holes into the curve of the profile.

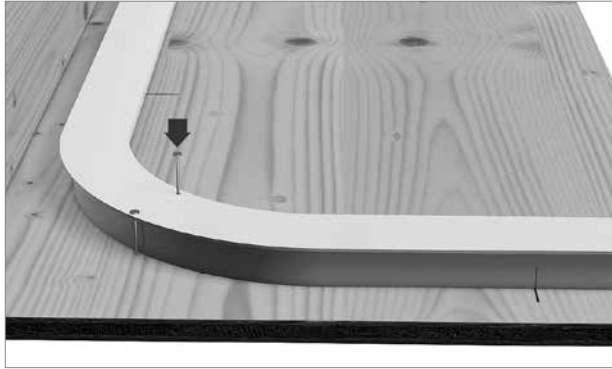

11. Fix the curtain profile to the panel using aluminium nails.



12. Concrete in the profile.

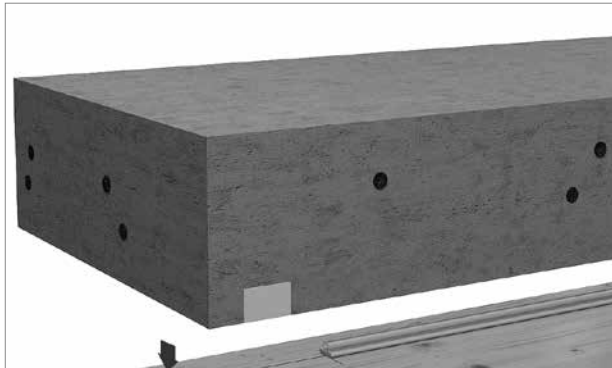

13. Remove the panel once hardened.

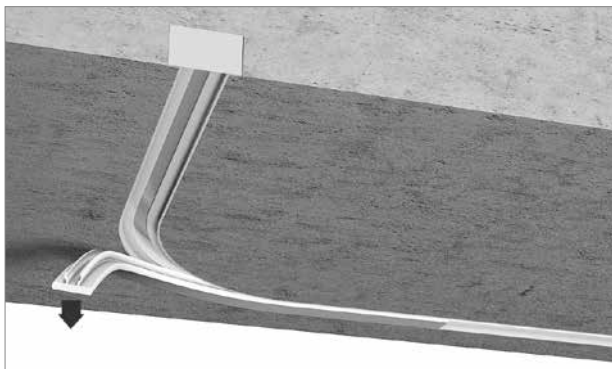

14. Remove the remaining protective strip.

Caution:

It is **essential** that you re-insert the protective strip if the ceiling still needs to be painted or use another means to protect it!

	Article description	Order no.
	<p>"maxi" curtain profile for embedding in concrete, VS57 standard</p> <p>Aluminium, grey, RAL 7038</p>	<p>20115.11</p>
	<p>Aluminium, white, RAL 9016</p>	<p>20115.20</p>
	<p>Stock lengths of 6 m</p>	<p>Made-to-measure + 20%</p>
	<p>Cover strip L115, white plastic</p>	<p>21047.20</p>
	<p>Stock lengths of 6 m</p>	<p>Made-to-measure + 20%</p>
	<p>Cover strip L115, plastic SOFT (for curved elements) for profile HM-20115 and HM-20117 for embedding in concrete</p>	<p>21047.20.W</p>
	<p>Stock lengths of 2 m</p>	<p>Made-to-measure + 20%</p>
	<p>Profile connector V115, spring steel</p>	<p>21217</p>
	<p>Aluminium nails 3.1 x 45 mm Box contains 500</p>	<p>991104</p>
	<p>Double head pin</p>	
	<p>1.6 x 24/35 mm</p>	<p>991102</p>
	<p>2.0 x 24/32 mm</p>	<p>991106</p>
	<p>2.0 x 24/32 mm, grooved</p>	<p>991107</p>

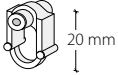
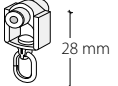
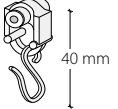
	Article description	Order no.
	Side cap S20115, grey plastic prevents the ingress of concrete water	21053.14
	Eyelet roller with shaft	25287
	Eyelet roller with rotatable eyelet	25288
	Eyelet roller with hook	25289

Bending service **Plan view** (seen from above). State room side.



Radii: from 250 to 300 mm

95.20115.1

Radii: up to 500 mm

95.20115.2

Radii: up to 1000 mm

95.20115.3

90° angle or angle of your choice



Non-standard radii and angles as per sketch

95.20115.4

Multifunctional curtain profile for embedding in concrete with "maxi" channel

HM-20117

Curtain profile for embedding in concrete, multifunctional for day and night curtains or panel curtain system, also suitable for use with eyelet rollers.

Profil.



Aluminium RAL 7038/100 my grey

Aluminium RAL 9016/100 my white

Stock lengths of 6 m

"maxi" accessories

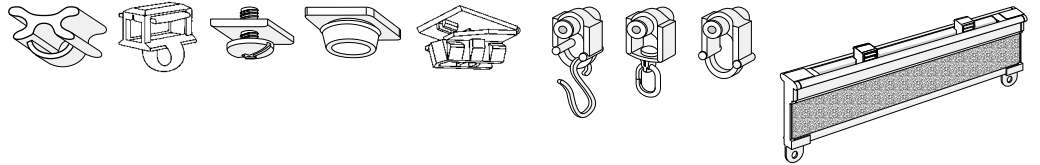

Installation accessories

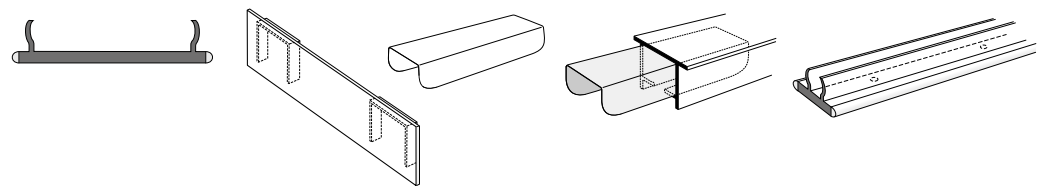

Installation

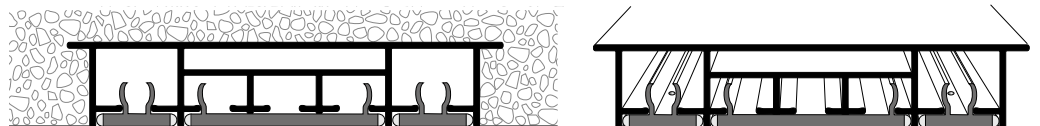

Services

Made-to-measure including opening / insert, mitre



This profile cannot be bent

Use stencil 19916.2 for the opening / entry of the central tracks.

Article description	Order no.
---------------------	-----------

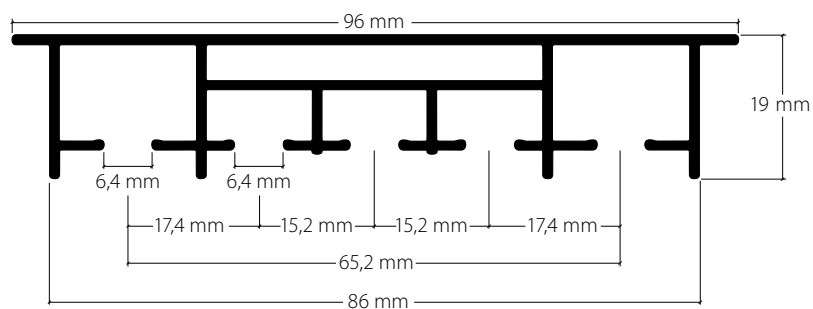

“maxi” multifunctional curtain profile for embedding in concrete, VS57 standard

Aluminium, grey, RAL 7038 20117.11

Aluminium, white, RAL 9016 20117.20



Stock lengths of 6 m

Made-to-measure + 20%

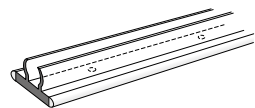

Installation strip L115, white plastic

21047.20



Stock lengths of 6 m

Made-to-measure + 20%



Cover strip L117, grey plastic
with sealing studs

21045.14

Cover strip L117, white plastic
with sealing studs

21045.20







Stock lengths of 6 m

Made-to-measure + 20%

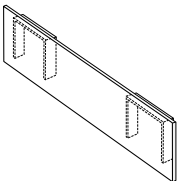

Profile connector V115, spring steel

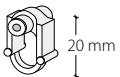
21217

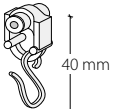
	Article description	Order no.
	Side cap S20117, grey plastic to prevent the ingress of concrete water	21050.14
	Aluminium nails 3.1 x 45 mm Box contains 500	991104
	Double head pin 1.6 x 24/35 mm	991102 1000 pc. 2000 pc.
	2.0 x 24/32 mm	991106 1000 pc. 2000 pc.
	2.0 x 24/32 mm, grooved	991107 1000 pc. 2000 pc.
	Eyelet roller with shaft	25287
	Eyelet roller with rotatable eyelet	25288
	Eyelet roller with hook	25289

Installation



1. Treat the curtain profile HM-20117 with silicone spray.

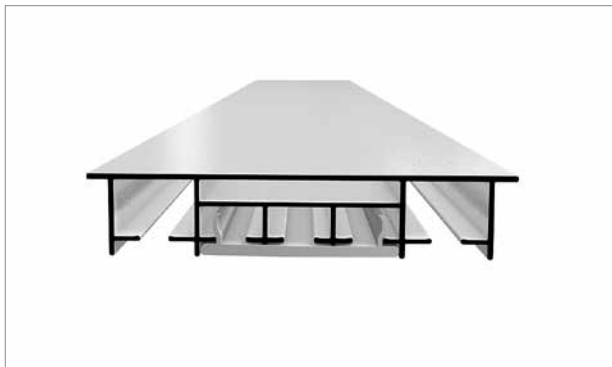

2. Insert cover strip 21045 into the inner tracks of the curtain profile.

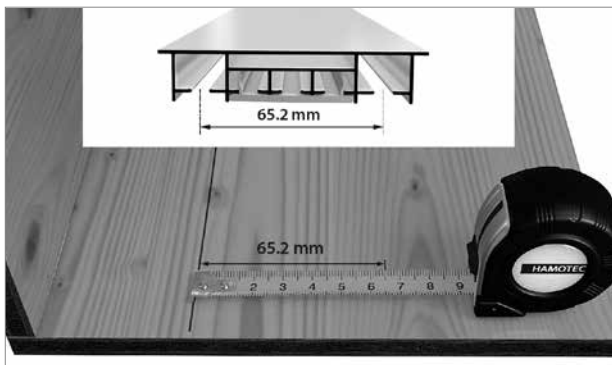

3. Mark the groove spacing between the two outer tracks of 65.2 mm on the panel.



4. Fix pre-drilled installation strips L115 to marking with Hamotec special nails.

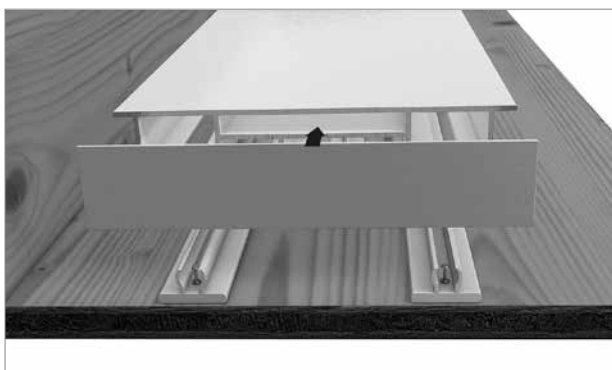

5. Seal the curtain profile with the side cap 21050 (to prevent the ingress of concrete water).

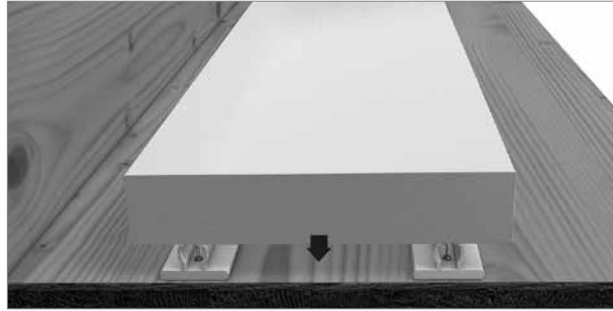

6. Clip the curtain profile onto the installation strips.



7. Concrete in the profile.

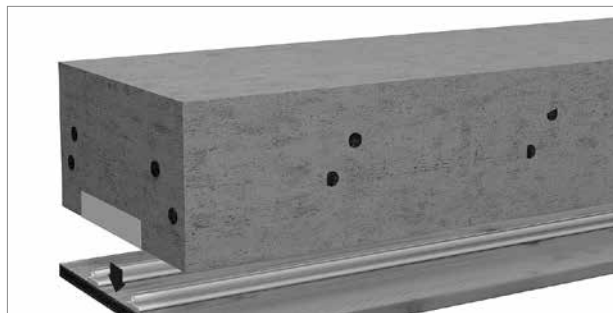

8. Remove the panel once hardened.

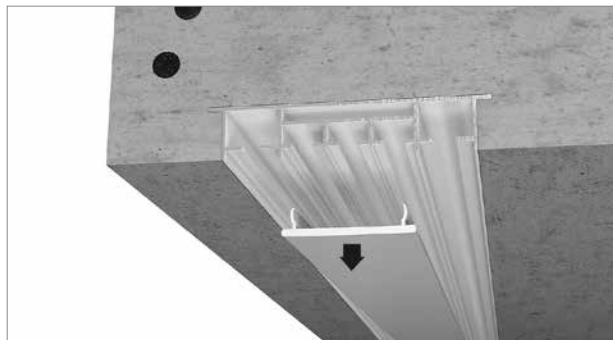

9. Remove the protective strip from the 3 inner tracks.

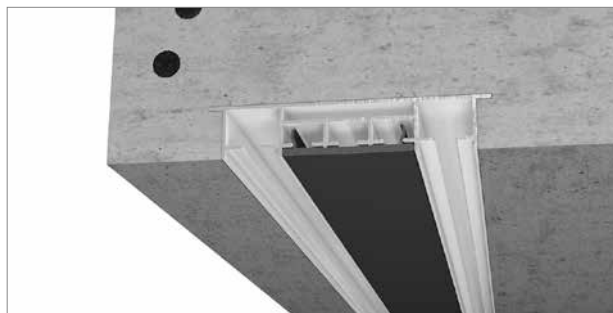

10. There is an option to insert a cover panel with 2-channel use.

Caution:

It is **essential** that you re-insert the protective strip if the ceiling still needs to be painted or use another means to protect it!