

2-channel curtain profile with "maxi" channel, VS57 standard, can be used with shadow gap strip

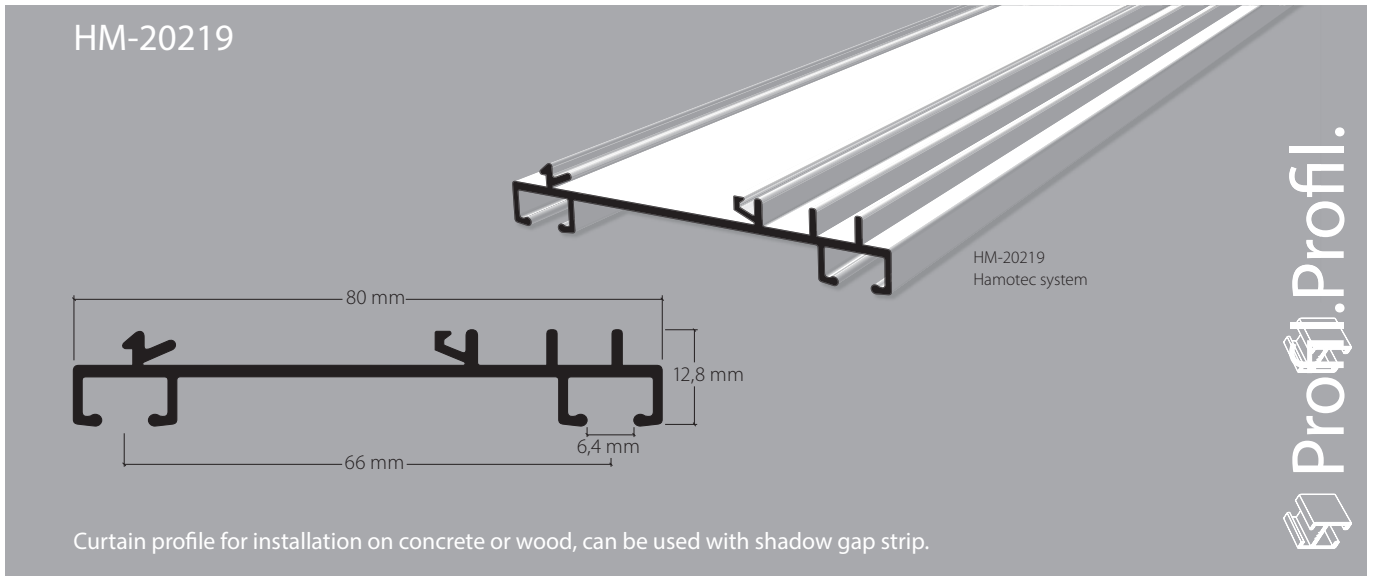

Aluminium, white, RAL 9016

Stock lengths of 4 m and 6 m

"maxi" accessories

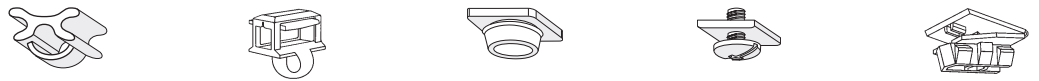

Installation accessories

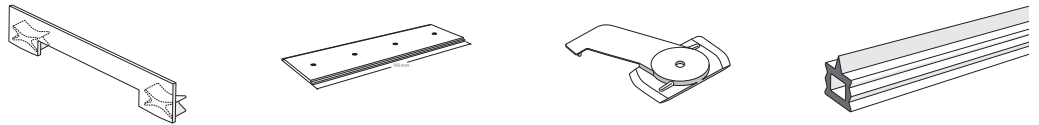

Services

Made-to-measure including opening and mitre



This profile cannot be bent

Installation

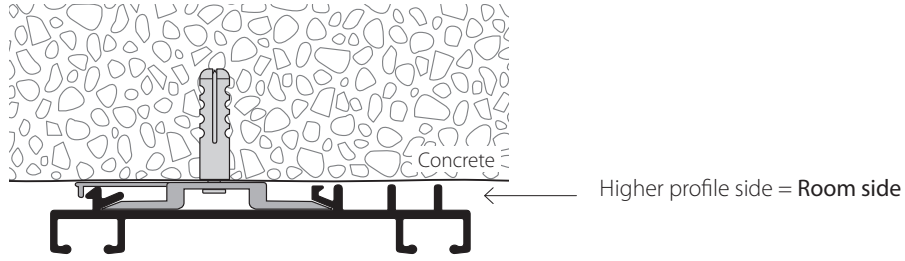

Caution: Opening / glider entry is only possible with "maxi" punch head.

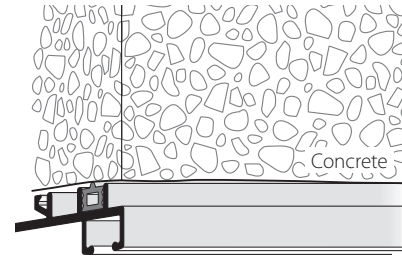
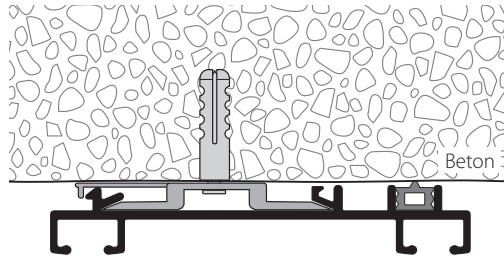

Features:

- Excellent inherent stability thanks to rigid aluminium
- Installation with clamping bolt
- The shadow gap strip compensates for unevenness in the ceiling

Installation of clamping bolt

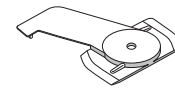

Fixings approx. every 40-50 cm

| Article description | Order no. |
|---------------------|-----------|
|---------------------|-----------|

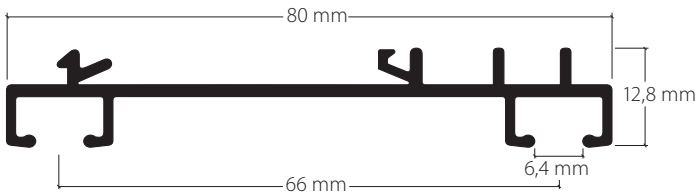

"maxi" 2-channel curtain profile
for installation with clamping bolt
can be used with shadow joint strip

Aluminium, white, RAL 9016 Other colours on request **20219.20**



Stock lengths of 4 m and 6 m

Made-to-measure + 20%

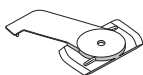

Installation of clamping bolt SP, white plastic **21039.20**
for profiles 20219, 20228

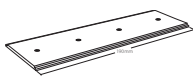

Profile connector, aluminium **21028**
for profiles 20219, 20228

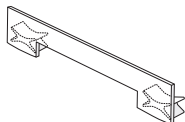

Side cap S20219
Plastic, white **21026.20**

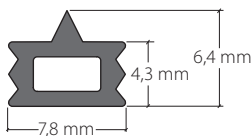

Shadow gap strip SF 219, PVC white **21060.20**
50 m rolls



Clamping bolt, plastic, prevents injuries / stripes on the ceiling when screwing in the clamp. (Hamotec development)