

Clip curtain profile with "maxi" channel, VS57 standard

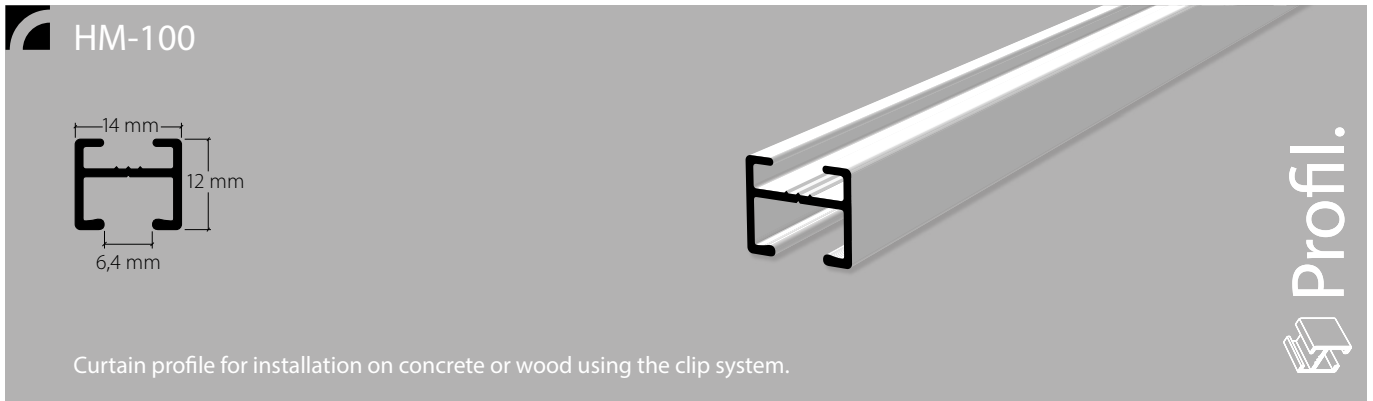

Aluminium, natural anodised

Aluminium, white, RAL 9016

Stock lengths of 6 m

"maxi" accessories



Installation accessories

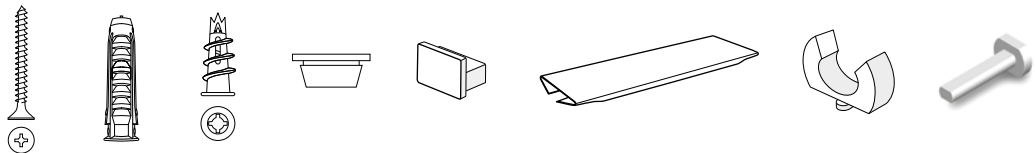

Services

Curved designs, cut to fixed dimensions including opening

Bending service

Plan view (seen from above). State room side.



Radii: from 80 mm
90° angle or angle of your choice



Non-standard radii and angles as per sketch

Installation

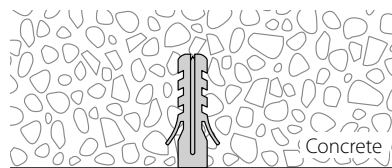

Installation
on concrete

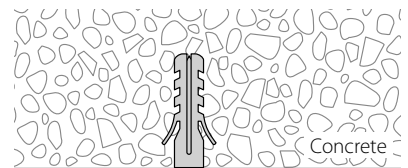

Plasterboard

Installation on concrete/plasterboard

Recommendation:
Install with SX5/5 x 30 mm dowels and SK 3.0 x 30 mm screws. Place installation clip every 30 cm.

Ceiling and wall installation with a Rail-Line bracket



Recommendation:
Position brackets every 30 cm.

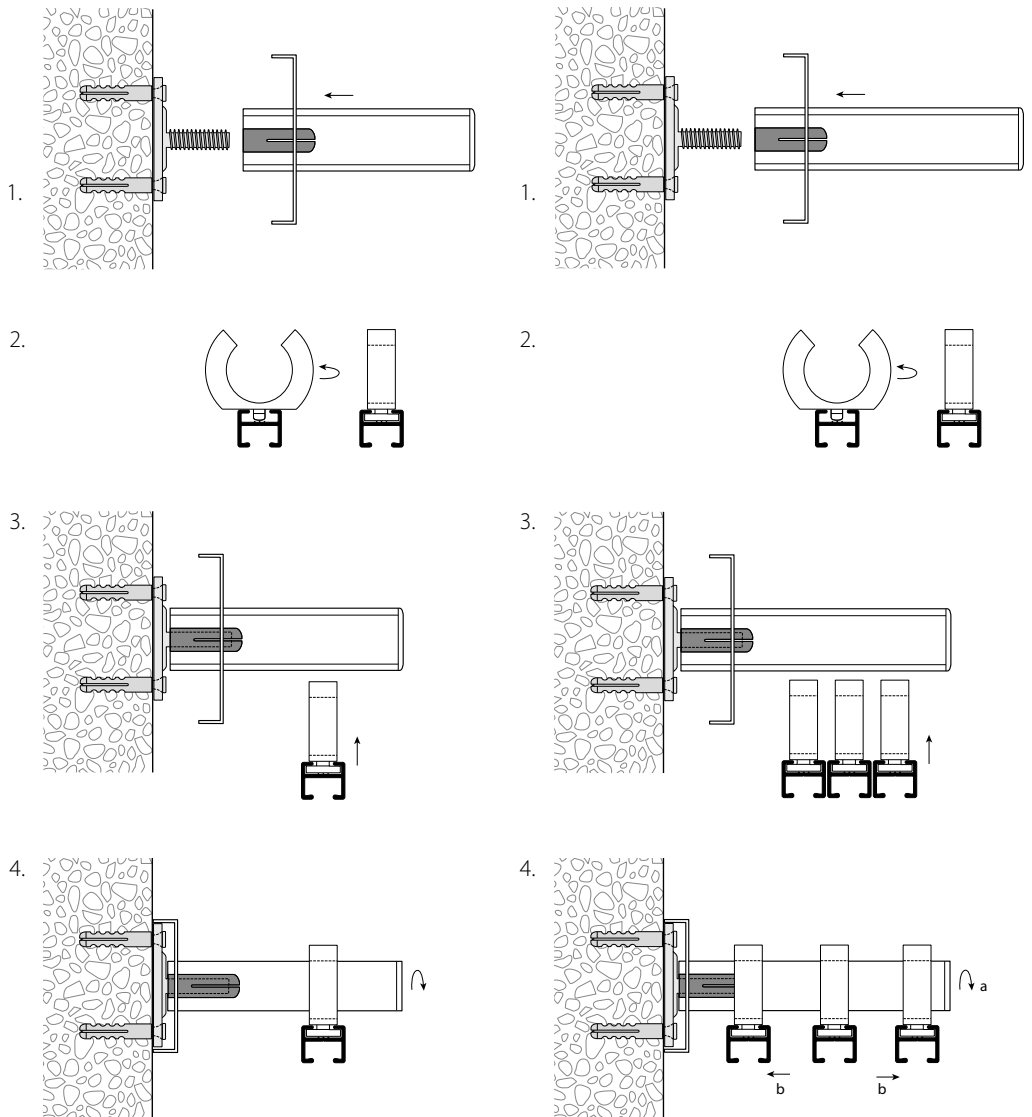
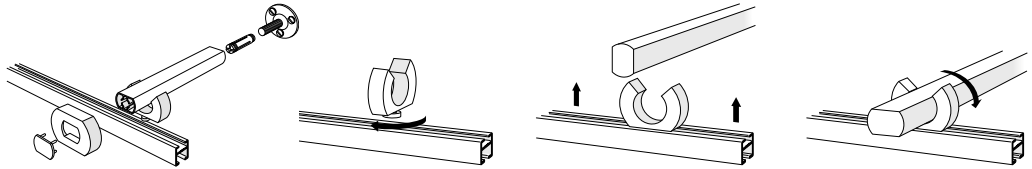





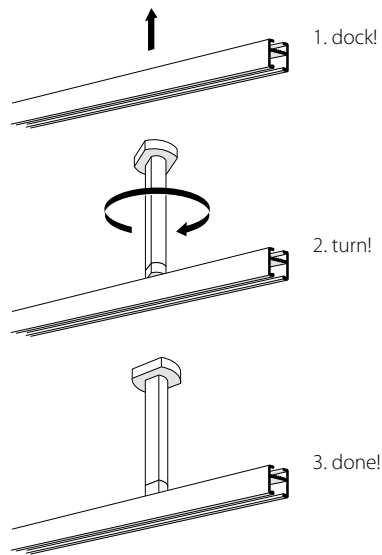
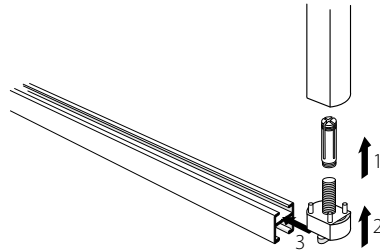

Ceiling installation with Rail-Line bracket

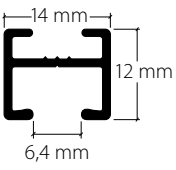

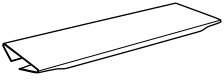
Recommendation:
Position brackets every 30 cm.

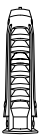

	Article description	Order no.
	<p>"maxi" clip curtain profile</p> <p>Aluminium, natural anodised</p>	<p>100.10</p>
	<p>Aluminium, white, RAL 9016</p>	<p>100.20</p>
	<p>Stock lengths of 6 m</p>	<p>Made-to-measure + 20%</p>
	<p>Profile connector V10, spring steel</p>	<p>11000</p>
	<p>Side cap S100</p>	
	<p>Plastic, grey</p>	<p>11006.14</p>
	<p>Plastic, white</p>	<p>11006.20</p>
	<p>Ceiling clip, plastic, grey for screws \varnothing 3.0 mm x ...</p>	<p>11005</p>
	<p>Dowel, plastic</p> <p>SX5 / 5 x 25 mm</p>	<p>55978</p>
	<p>Dry lining dowel 12 x 30 mm, plastic for installation on plasterboard</p>	<p>55981</p>
	<p>Bracket-tube connector</p>	
	<p>Plastic, aluminium coloured</p>	<p>21415.10</p>
	<p>Plastic, white</p>	<p>21415.20</p>

	Article description	Order no.
--	---------------------	-----------

	Spacer for ceiling bracket	
	Plastic, aluminium coloured	11010.10
	Plastic, white	11010.20

	Rail-Line wall bracket, aluminium, undrilled including bracket cap, wall cover, installation plate, brass sleeve, fully assembled		
		Projection up to	
	Matt aluminium	7 cm	21431.12
		10 cm	21432.12
		15 cm	21434.12
	Aluminium, white	7 cm	21431.20
		10 cm	21432.20
15 cm		21434.20	

Bending service	Plan view (seen from above). State room side.	
		95100.1
	Radii: from 80 to 200 mm	
		95100.2
	Radii: up to 500 mm	
		95100.3
	Radii: up to 1000 mm	
	90° angle or angle of your choice	
		95100.4
	Non-standard radii and angles as per sketch	

Plan view drawing

**Ordering information**

- The profile is always seen from above with the glide channel at the bottom
- With profiles with clamping bolt assembly, please state room side
- Radii are always understood as being from the inside of the profile
- Curved designs cannot be returned in the event of incorrect dimensions
- Special bends only with 1:1 template

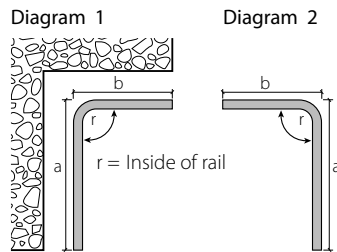
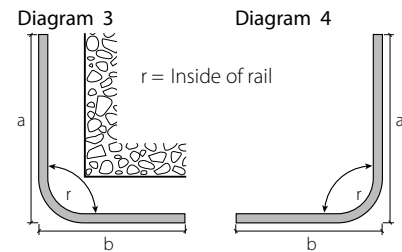
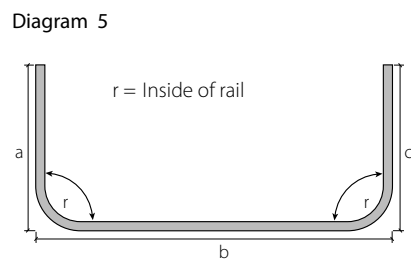
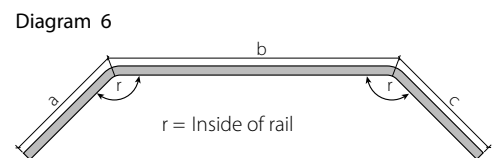
**Dimensions: external and view from above****Dimensions: external and view from above****Dimensions: external and view from above**

Dimension a: End of profile to centre of radius / bend
 Dimension b: Centre of radius to centre of radius
 Dimension c: Centre of radius to end of radius

Dimensions: external and view from above