

Multifunctional curtain profile for embedding in concrete with "maxi" channel

HM-20117

Curtain profile for embedding in concrete, multifunctional for day and night curtains or panel curtain system, also suitable for use with eyelet rollers.

Profil.



Aluminium RAL 7038/100 my grey

Aluminium RAL 9016/100 my white

Stock lengths of 6 m

"maxi" accessories

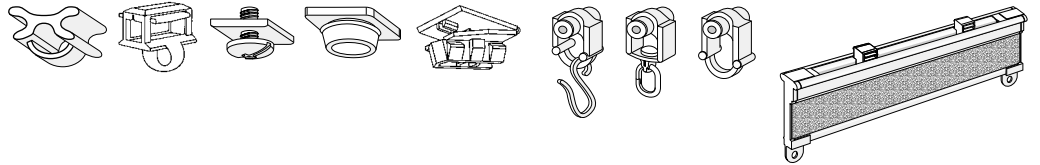

Installation accessories

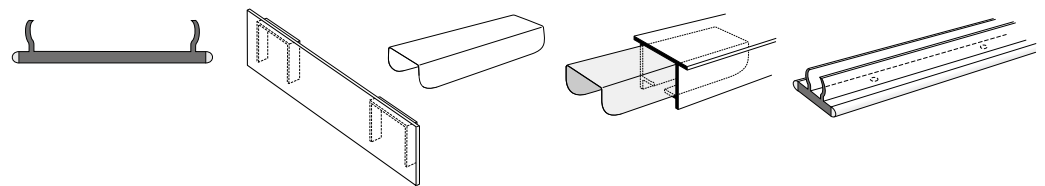

Installation

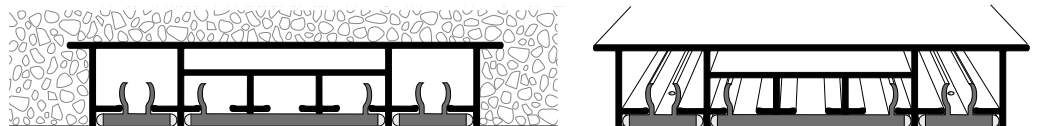

Services

Made-to-measure including opening/insert, mitre



This profile cannot be bent

Use stencil 19916.2 for the opening/entry of the central tracks.

Article description

Order no.

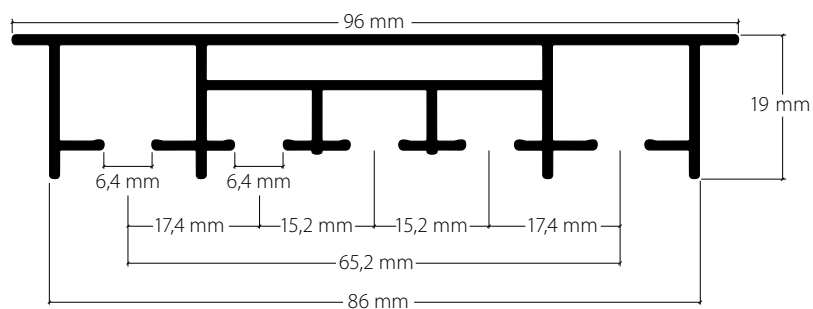

“maxi” multifunctional curtain profile for embedding in concrete, VS57 standard

Aluminium, grey, RAL 7038

20117.11

Aluminium, white, RAL 9016

20117.20



Stock lengths of 6 m

Made-to-measure + 20%

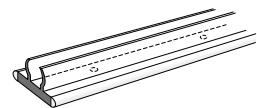

Installation strip L115, white plastic

21047.20



Stock lengths of 6 m

Made-to-measure + 20%

Cover strip L117, grey plastic
with sealing studs

21045.14

Cover strip L117, white plastic
with sealing studs

21045.20







Stock lengths of 6 m

Made-to-measure + 20%

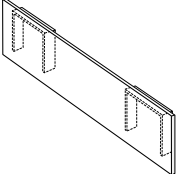

Profile connector V115, spring steel

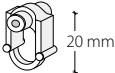
21217

	Article description	Order no.	
	Side cap S20117, grey plastic to prevent the ingress of concrete water	21050.14	
	Aluminium nails 3.1 x 45 mm Box contains 500	991104	
	Double head pin	991102	1000 pc. 2000 pc.
	1.6 x 24/35 mm		
	2.0 x 24/32 mm	991106	1000 pc. 2000 pc.
	2.0 x 24/32 mm, grooved	991107	1000 pc. 2000 pc.
	Eyelet roller with shaft	25287	
	Eyelet roller with rotatable eyelet	25288	
	Eyelet roller with hook	25289	

Installation



1. Treat the curtain profile HM-20117 with silicone spray.

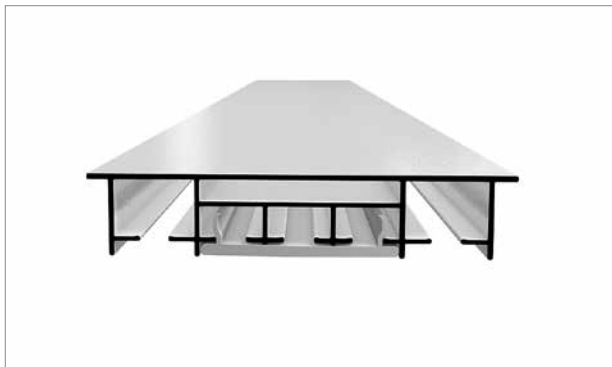

2. Insert cover strip 21045 into the inner tracks of the curtain profile.

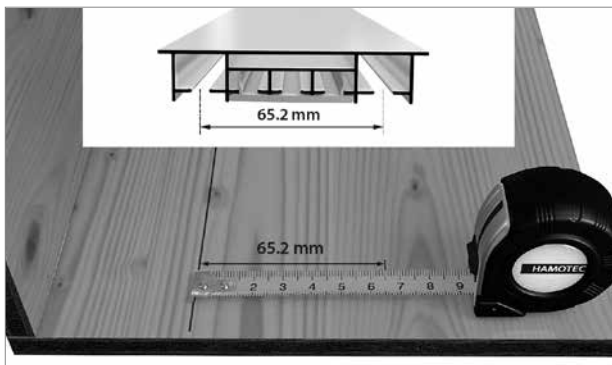

3. Mark the groove spacing between the two outer tracks of 65.2 mm on the panel.



4. Fix pre-drilled installation strips L115 to marking with Hamotec special nails.

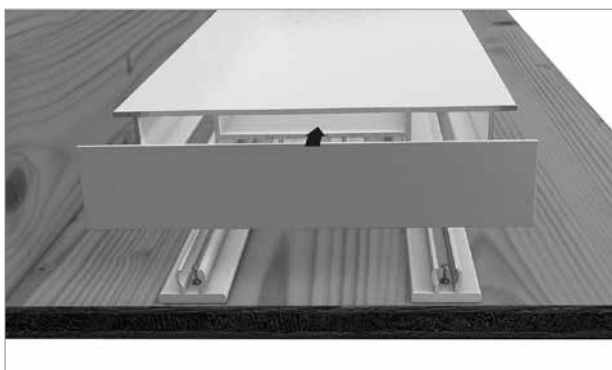

5. Seal the curtain profile with the side cap 21050 (to prevent the ingress of concrete water).

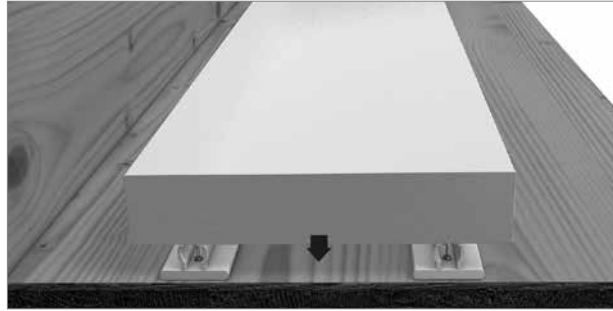

6. Clip the curtain profile onto the installation strips.



7. Concrete in the profile.

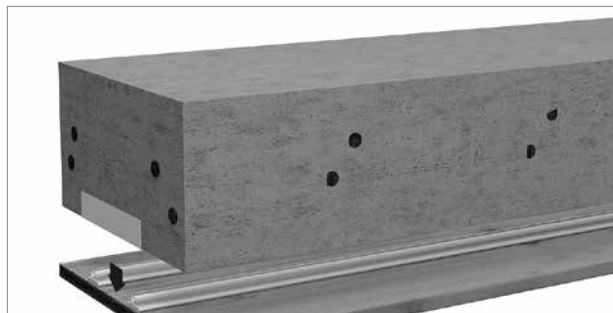

8. Remove the panel once hardened.

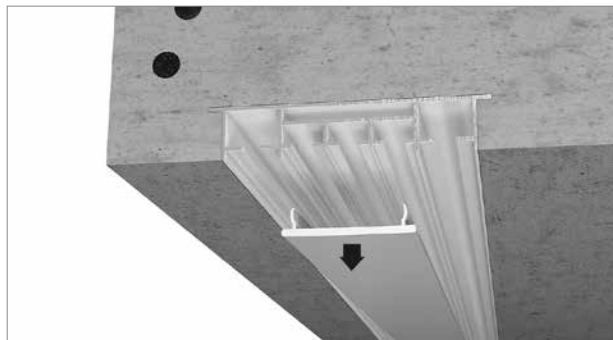

9. Remove the protective strip from the 3 inner tracks.

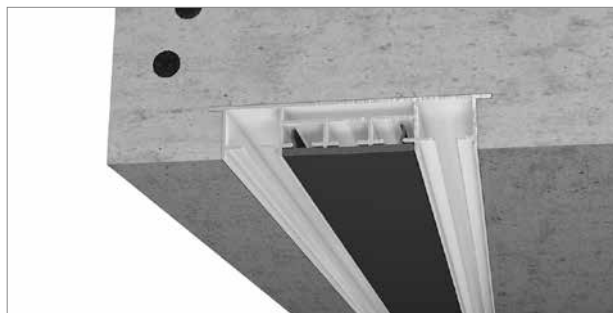

10. There is an option to insert a cover panel with 2-channel use.

Caution:

It is **essential** that you re-insert the protective strip if the ceiling still needs to be painted or use another means to protect it!